

# Machine-Level Programming II: Procedures

15-213/18-213/14-513/15-513: Introduction to Computer Systems  
7<sup>th</sup> Lecture, February 7<sup>th</sup> 2019

# Today

## ■ Procedures

- Mechanisms
- Stack Structure
- Calling Conventions
  - Passing control
  - Passing data
  - Managing local data
- Illustration of Recursion

# Mechanisms in Procedures

## ■ Passing control

- To beginning of procedure code
- Back to return point

## ■ Passing data

- Procedure arguments
- Return value

## ■ Memory management

- Allocate during procedure execution
- Deallocate upon return

## ■ Mechanisms all implemented with machine instructions

## ■ x86-64 implementation of a procedure uses only those mechanisms required

```
P (...) {  
    •  
    •  
    y = Q(x);  
    print(y)  
    •  
}
```

```
int Q(int i)  
{  
    int t = 3*i;  
    int v[10];  
    •  
    •  
    return v[t];  
}
```

# Mechanisms in Procedures

## ■ Passing control

- To beginning of procedure code
- Back to return point

## ■ Passing data

- Procedure arguments
- Return value

## ■ Memory management

- Allocate during procedure execution
- Deallocate upon return

## ■ Mechanisms all implemented with machine instructions

## ■ x86-64 implementation of a procedure uses only those mechanisms required

```
P (...) {  
    •  
    •  
    y = Q(x);  
    print(y)  
    •  
}
```

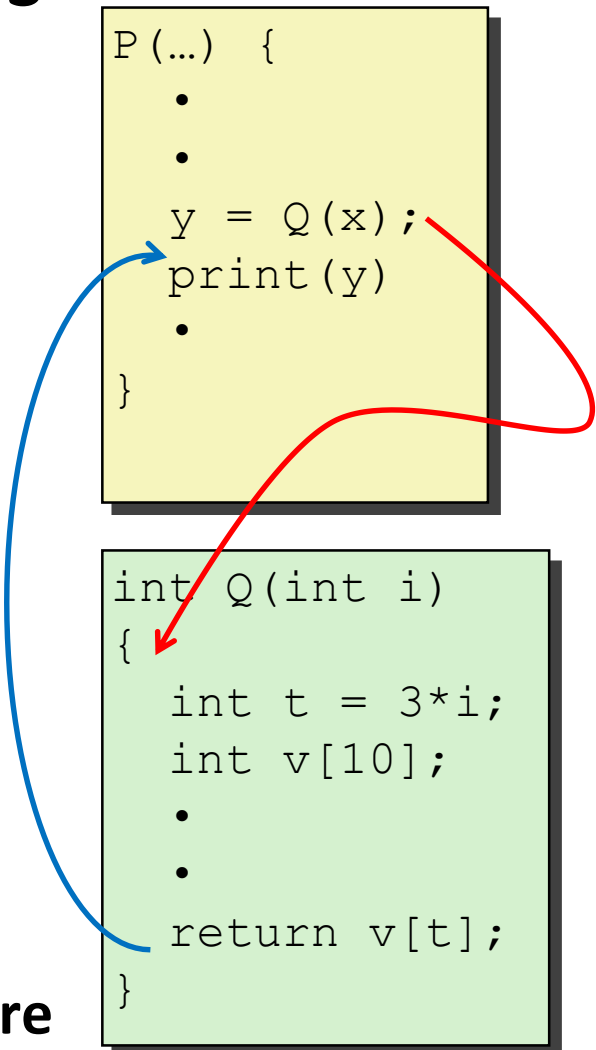

```
int Q(int i)  
{  
    int t = 3*i;  
    int v[10];  
    •  
    •  
    return v[t];  
}
```

# Mechanisms in Procedures

## ■ Passing control

- To beginning of procedure code
- Back to return point

## ■ Passing data

- Procedure arguments
- Return value

## ■ Memory management

- Allocate during procedure execution
- Deallocate upon return

## ■ Mechanisms all implemented with machine instructions

## ■ x86-64 implementation of a procedure uses only those mechanisms required

```
P (...) {  
  •  
  •  
  y = Q(x);  
  print(y)  
  •  
}
```

```
int Q(int i)  
{  
  int t = 3*i;  
  int v[10];  
  •  
  •  
  return v[t];  
}
```

# Mechanisms in Procedures

## ■ Passing control

- To beginning of procedure code
- Back to return point

## ■ Passing data

- Procedure arguments
- Return value

## ■ Memory management

- Allocate during procedure execution
- Deallocate upon return

## ■ Mechanisms all implemented with machine instructions

## ■ x86-64 implementation of a procedure uses only those mechanisms required

```
P (...) {  
    •  
    •  
    y = Q(x);  
    print(y)  
    •  
}
```

```
int Q(int i)  
{  
    int t = 3*i;  
    int v[10];  
    •  
    •  
    return v[t];  
}
```

# Mechanisms in Procedures

```
P(...) {
```

Machine instructions implement the mechanisms, but the choices are determined by designers. These choices make up the **Application Binary Interface (ABI)**.

- Deallocate upon return
- **Mechanisms all implemented with machine instructions**
- **x86-64 implementation of a procedure uses only those mechanisms required**

```
int v[10];  
·  
·  
return v[t];  
}
```

# Today

## ■ Procedures

- Mechanisms
- **Stack Structure**
- Calling Conventions
  - Passing control
  - Passing data
  - Managing local data
- Illustration of Recursion



# x86-64 Stack

## ■ Region of memory managed with stack discipline

- Memory viewed as array of bytes.
- Different regions have different purposes.
- (Like ABI, a policy decision)

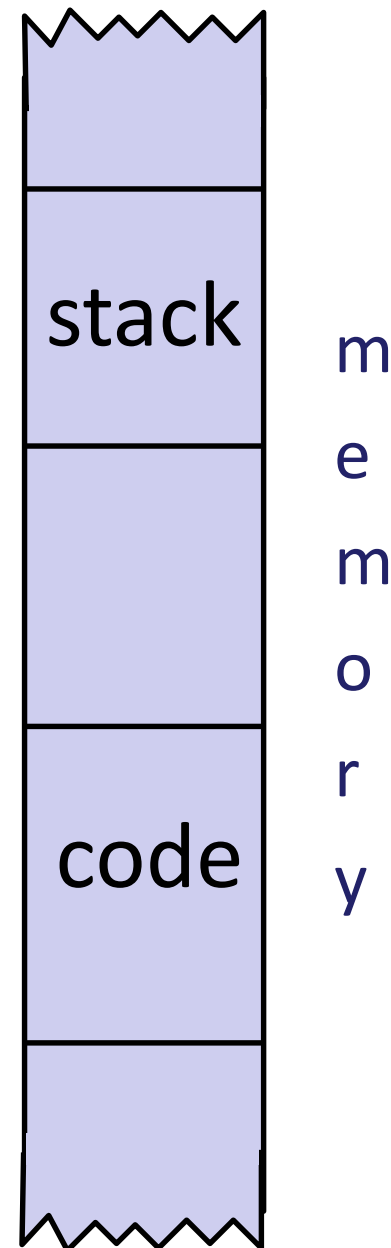

# x86-64 Stack

- Region of memory managed with stack discipline

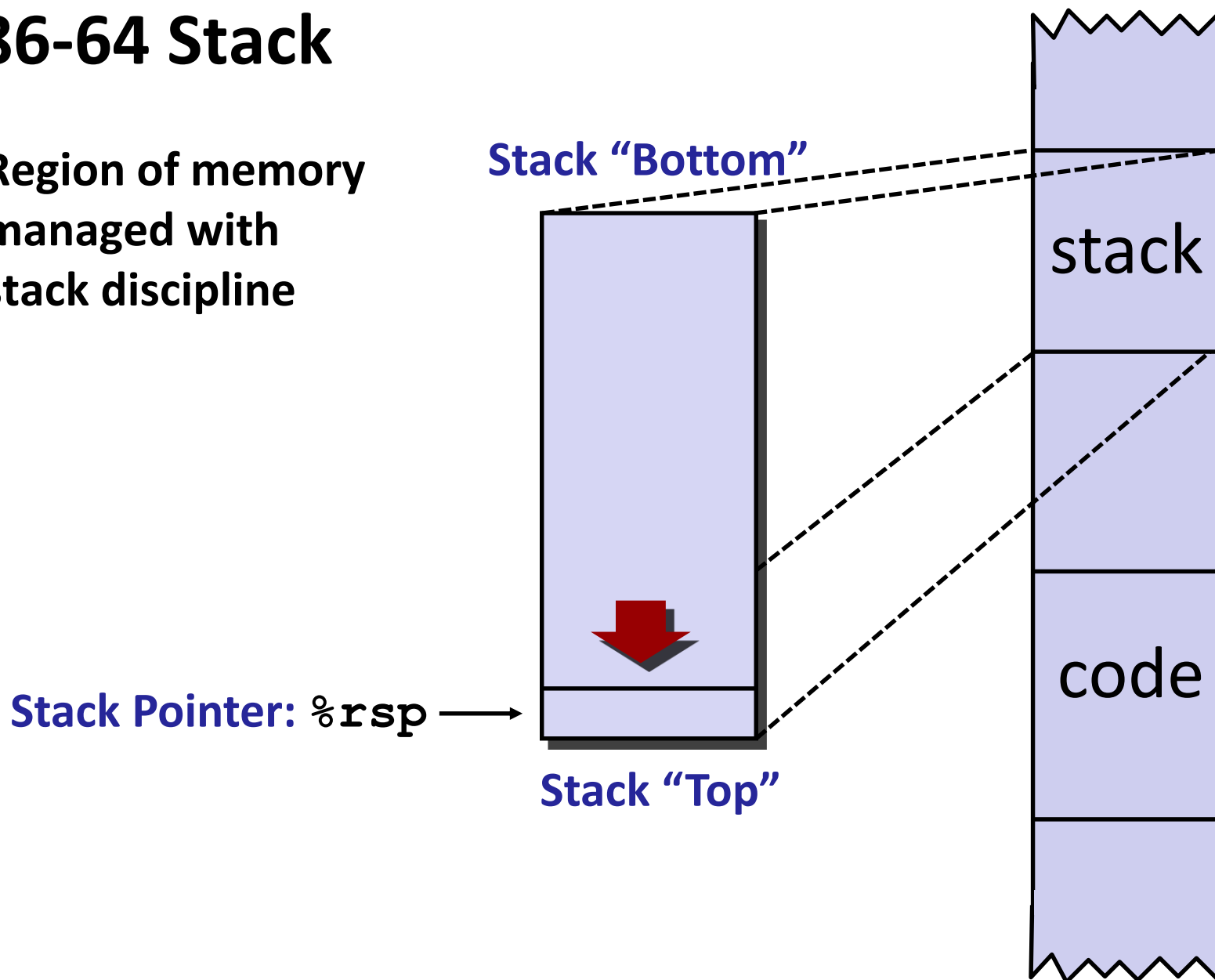

# x86-64 Stack

- Region of memory managed with stack discipline
- Grows toward lower addresses
- Register `%rsp` contains lowest stack address
  - address of “top” element

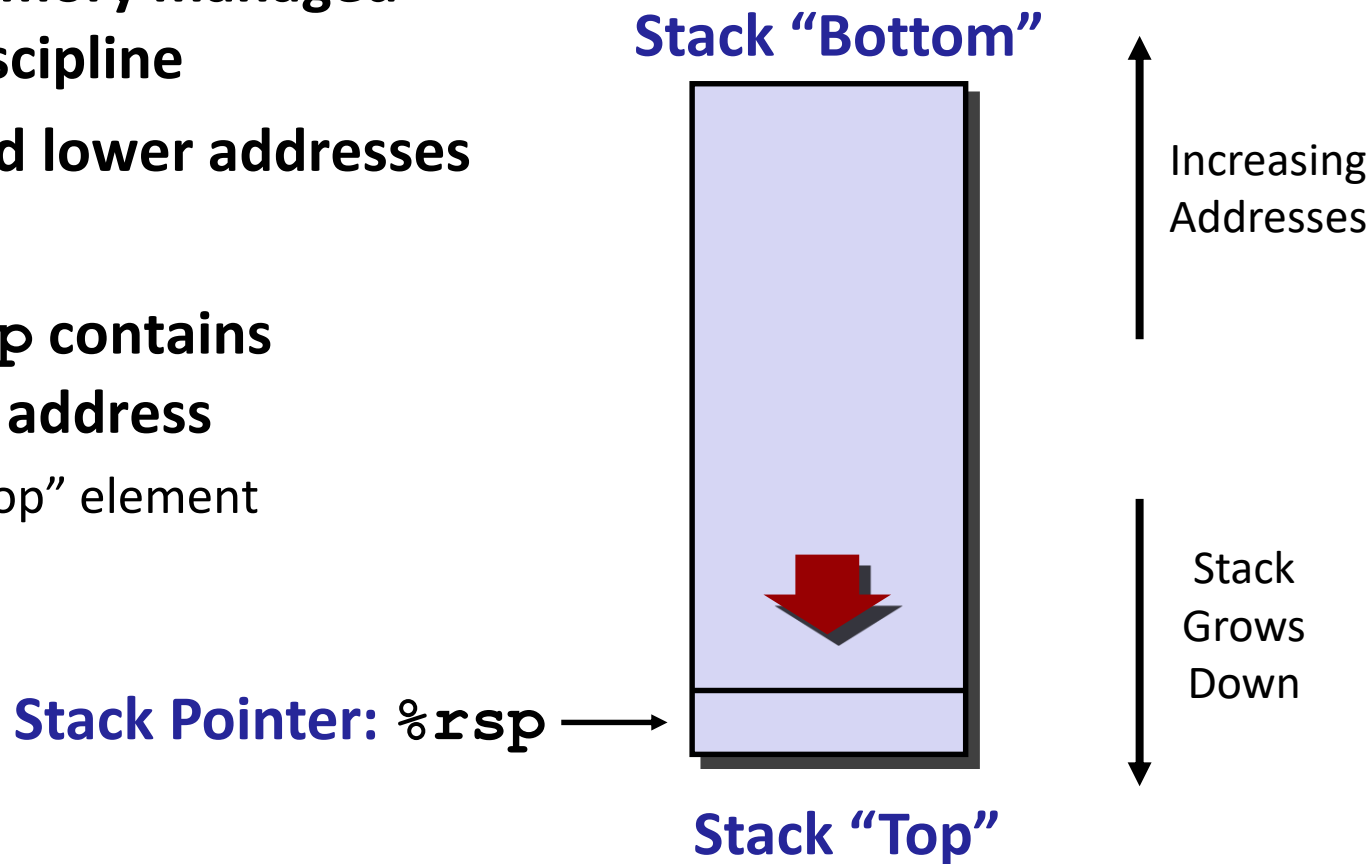

# x86-64 Stack: Push

## ■ `pushq Src`

- Fetch operand at *Src* val
- Decrement `%rsp` by 8
- Write operand at address given by `%rsp`

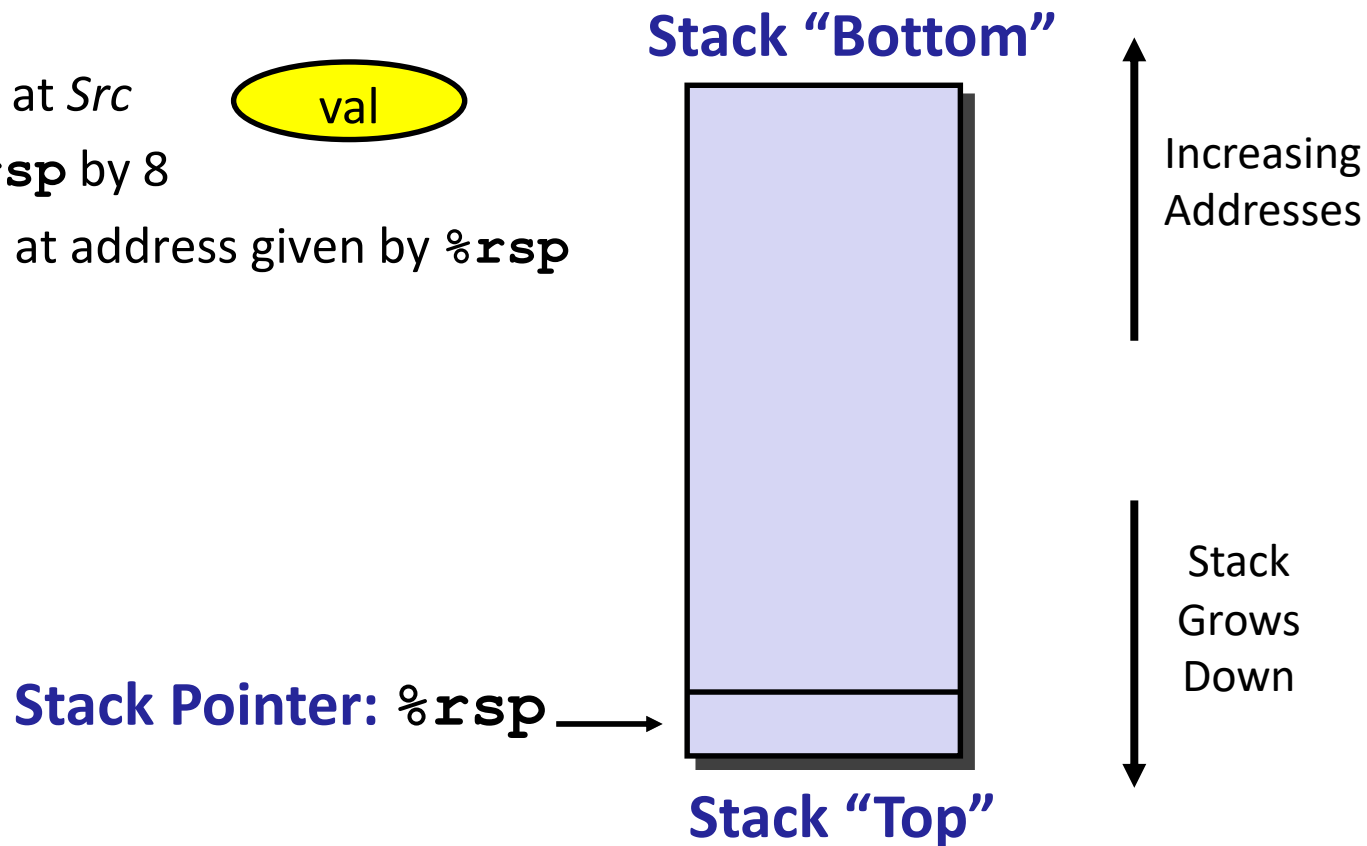

# x86-64 Stack: Push

## ■ `pushq Src`

- Fetch operand at *Src* val
- Decrement `%rsp` by 8
- Write operand at address given by `%rsp`

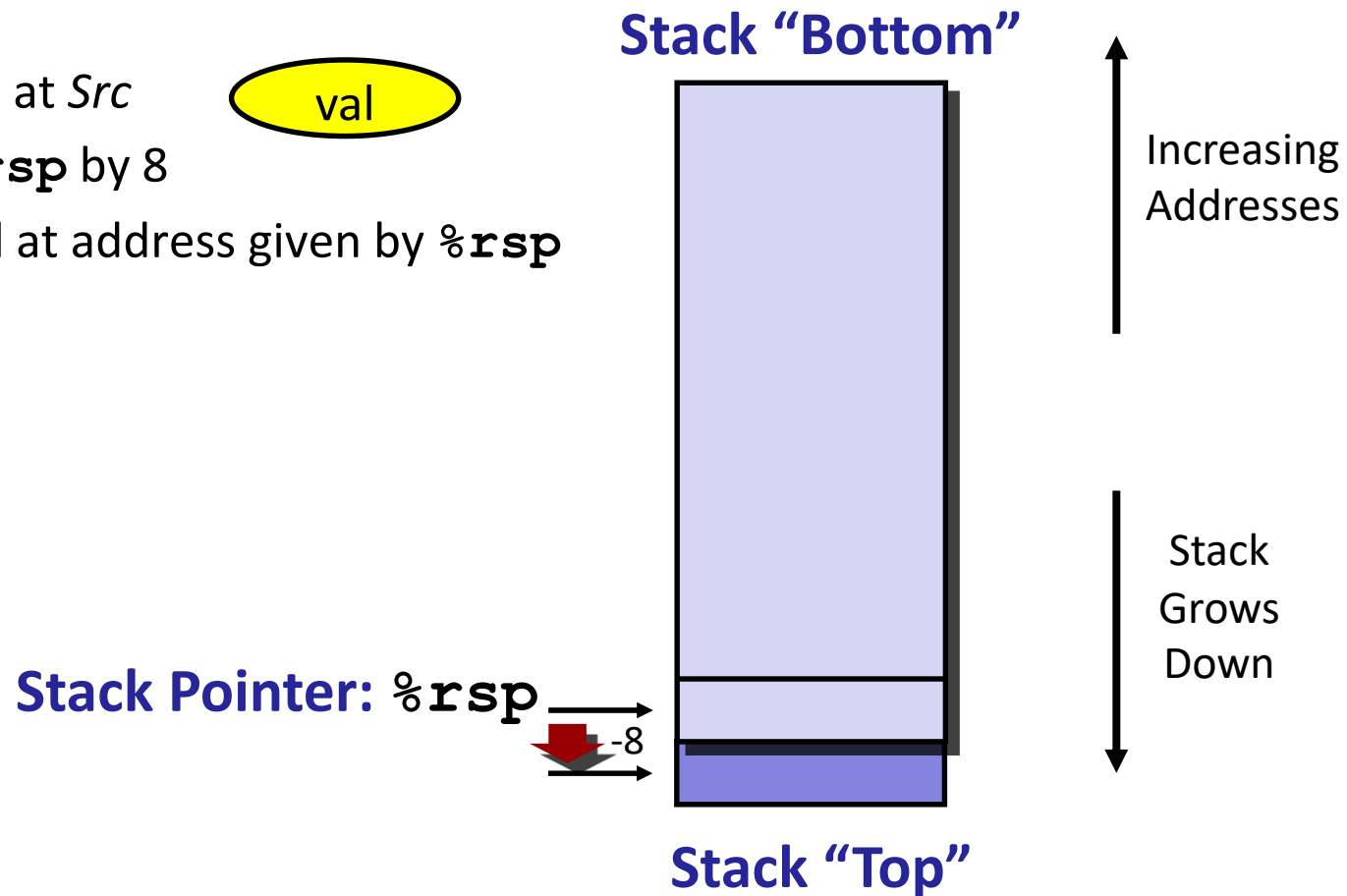

# x86-64 Stack: Pop

## ■ `popq Dest`

- Read value at address given by `%rsp`
- Increment `%rsp` by 8
- Store value at `Dest` (usually a register)

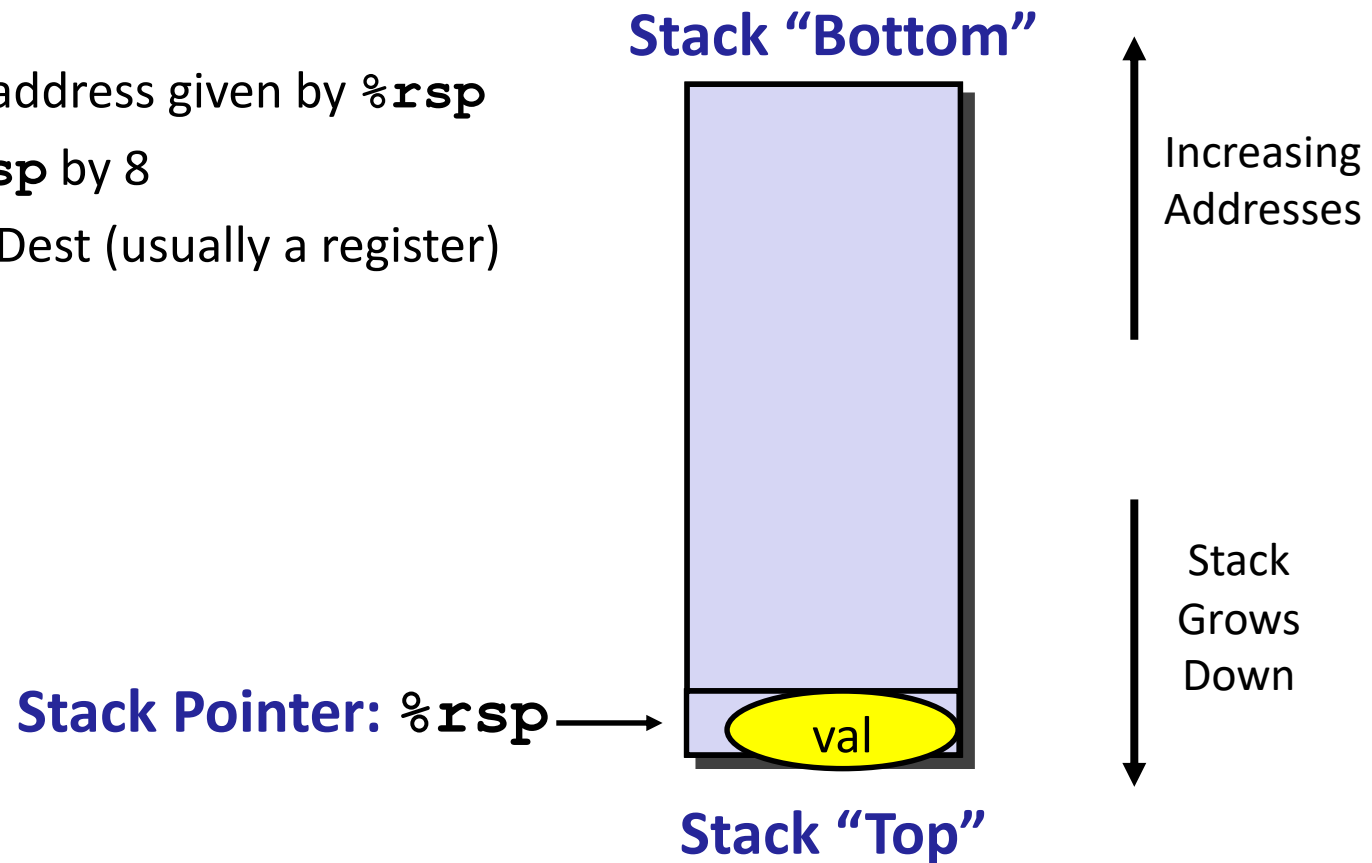

# x86-64 Stack: Pop

## ■ `popq Dest`

- Read value at address given by `%rsp`
- Increment `%rsp` by 8
- Store value at `Dest` (usually a register)

val

Stack Pointer: `%rsp`

+8

Stack "Bottom"

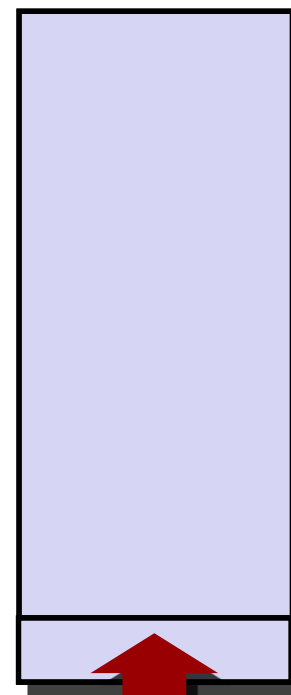

Increasing  
Addresses

Stack  
Grows  
Down

Stack "Top"

# x86-64 Stack: Pop

## ■ `popq Dest`

- Read value at address given by `%rsp`
- Increment `%rsp` by 8
- Store value at `Dest` (usually a register)

Stack Pointer: `%rsp` →

Stack "Bottom"

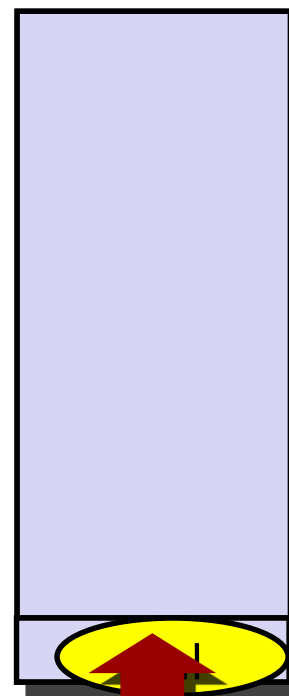

Increasing  
Addresses

Stack  
Grows  
Down

(The memory doesn't change,  
only the value of `%rsp`)



# Today

## ■ Procedures

- Mechanisms
- Stack Structure
- Calling Conventions
  - **Passing control**
  - Passing data
  - Managing local data
- Illustration of Recursion

# Code Examples

```
void multstore(long x, long y, long *dest)
{
    long t = mult2(x, y);
    *dest = t;
}
```

```
0000000000400540 <multstore>:
400540: push    %rbx          # Save %rbx
400541: mov     %rdx,%rbx     # Save dest
400544: callq  400550 <mult2> # mult2(x,y)
400549: mov     %rax,(%rbx)   # Save at dest
40054c: pop     %rbx          # Restore %rbx
40054d: retq                               # Return
```

```
long mult2(long a, long b)
{
    long s = a * b;
    return s;
}
```

```
0000000000400550 <mult2>:
400550: mov     %rdi,%rax     # a
400553: imul   %rsi,%rax     # a * b
400557: retq                               # Return
```

# Procedure Control Flow

- Use stack to support procedure call and return
- **Procedure call:** `call label`
  - Push return address on stack
  - Jump to *label*
- **Return address:**
  - Address of the next instruction right after call
  - Example from disassembly
- **Procedure return:** `ret`
  - Pop address from stack
  - Jump to address

# Control Flow Example #1

```

0000000000400540 <multstore>:
.
.
400544: callq   400550 <mult2>
400549: mov    %rax, (%rbx)
.
.

```

```

0000000000400550 <mult2>:
400550: mov    %rdi,%rax
.
.
400557: retq

```

0x130

0x128

0x120

%rsp

%rip

0x120

0x400544

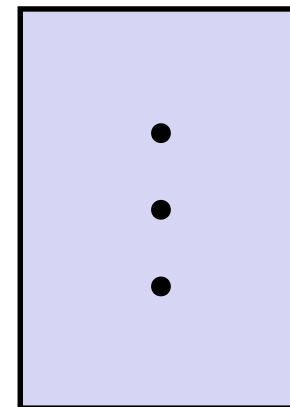

%rsp

%rip

0x120

0x400544

# Control Flow Example #2

```

0000000000400540 <multstore>:
.
.
400544: callq   400550 <mult2>
400549: mov    %rax, (%rbx) ←
.
.

```

```

0000000000400550 <mult2>:
400550: mov    %rdi,%rax ←
.
.
400557: retq

```

0x130

0x128

0x120

0x118

0x400549

%rsp

0x118

%rip

0x400550

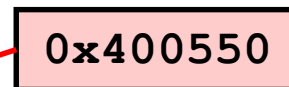
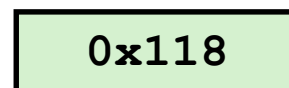
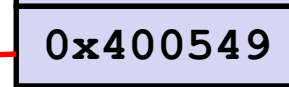
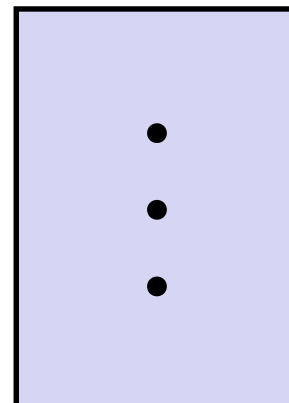

# Control Flow Example #3

```

0000000000400540 <multstore>:
.
.
400544: callq   400550 <mult2>
400549: mov    %rax, (%rbx) ←
.
.

```

```

0000000000400550 <mult2>:
400550: mov    %rdi,%rax
.
.
400557: retq ←

```

0x130

0x128

0x120

0x118

0x400549

%rsp

0x118

%rip

0x400557

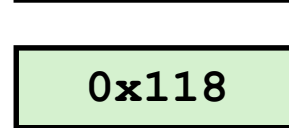
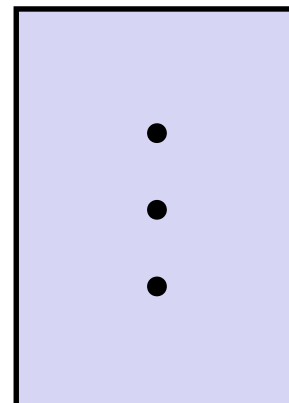

# Control Flow Example #4

```

0000000000400540 <multstore>:
.
.
400544: callq   400550 <mult2>
400549: mov    %rax, (%rbx)
.
.

```

```

0000000000400550 <mult2>:
400550: mov    %rdi,%rax
.
.
400557: retq

```

0x130

0x128

0x120

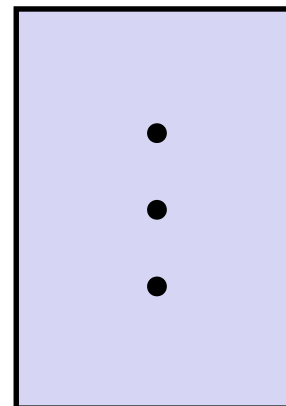

%rsp

0x120

%rip

0x400549

# Today

## ■ Procedures

- Mechanisms
- Stack Structure
- Calling Conventions
  - Passing control
  - **Passing data**
  - Managing local data
- Illustrations of Recursion & Pointers



# Procedure Data Flow

## Registers

### ■ First 6 arguments

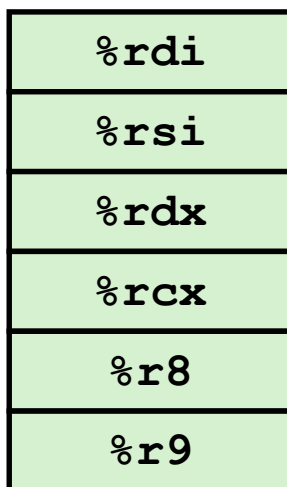

### ■ Return value

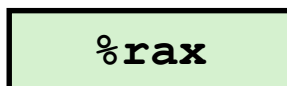

## Stack

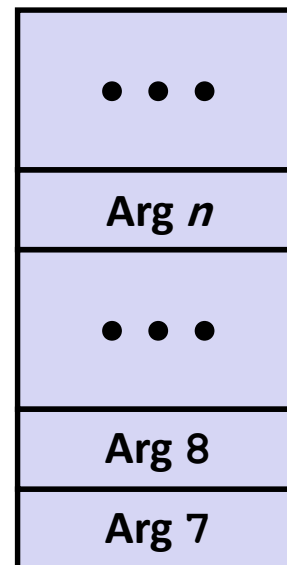

### ■ Only allocate stack space when needed

# Data Flow Examples

```
void multstore
(long x, long y, long *dest)
{
    long t = mult2(x, y);
    *dest = t;
}
```

```
0000000000400540 <multstore>:
    # x in %rdi, y in %rsi, dest in %rdx
    ...
400541: mov     %rdx,%rbx        # Save dest
400544: callq  400550 <mult2>    # mult2(x,y)
    # t in %rax
400549: mov     %rax,(%rbx)      # Save at dest
    ...
```

```
long mult2
(long a, long b)
{
    long s = a * b;
    return s;
}
```

```
0000000000400550 <mult2>:
    # a in %rdi, b in %rsi
400550: mov     %rdi,%rax        # a
400553: imul   %rsi,%rax        # a * b
    # s in %rax
400557: retq                               # Return
```

# Today

## ■ Procedures

- Mechanisms
- Stack Structure
- Calling Conventions
  - Passing control
  - Passing data
  - **Managing local data**
- Illustration of Recursion

# Stack-Based Languages

## ■ Languages that support recursion

- e.g., C, Pascal, Java
- Code must be “*Reentrant*”
  - Multiple simultaneous instantiations of single procedure
- Need some place to store state of each instantiation
  - Arguments
  - Local variables
  - Return pointer

## ■ Stack discipline

- State for given procedure needed for limited time
  - From when called to when return
- Callee returns before caller does

## ■ Stack allocated in *Frames*

- state for single procedure instantiation

# Call Chain Example

```
yoo (...)  
{  
  .  
  .  
  who ();  
  .  
  .  
}
```

```
who (...)  
{  
  . . .  
  amI ();  
  . . .  
  amI ();  
  . . .  
}
```

```
amI (...)  
{  
  .  
  .  
  amI ();  
  .  
  .  
}
```

**Procedure amI () is recursive**

## Example Call Chain

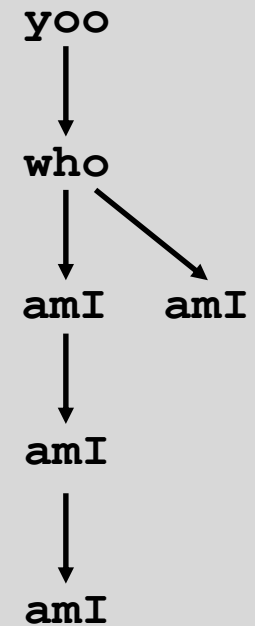

# Stack Frames

## ■ Contents

- Return information
- Local storage (if needed)
- Temporary space (if needed)

Frame Pointer: `%rbp`  
(Optional)

Stack Pointer: `%rsp`

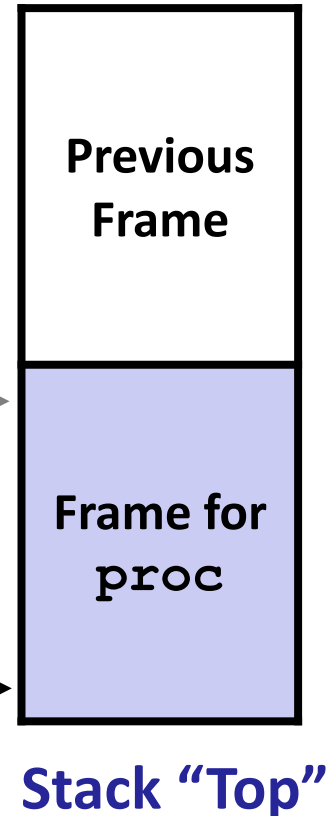

## ■ Management

- Space allocated when enter procedure
  - “Set-up” code
  - Includes push by `call` instruction
- Deallocated when return
  - “Finish” code
  - Includes pop by `ret` instruction

# Example

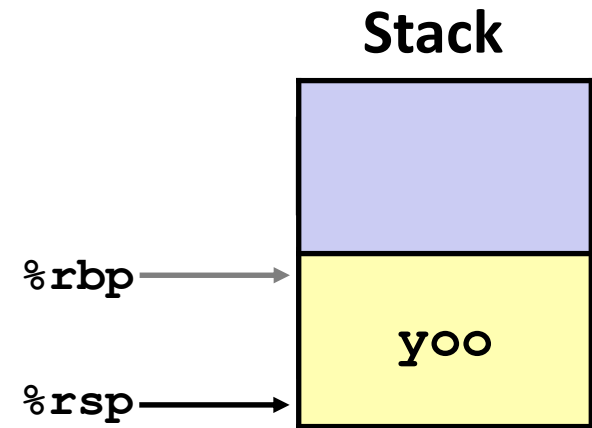
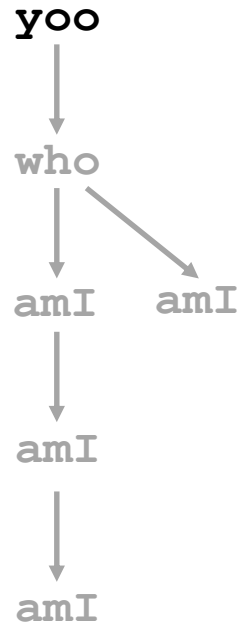
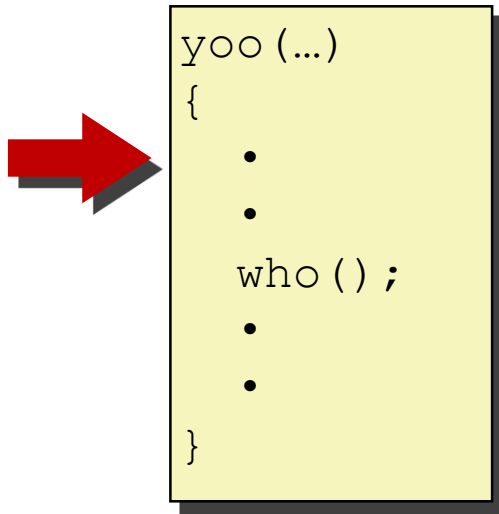

# Example

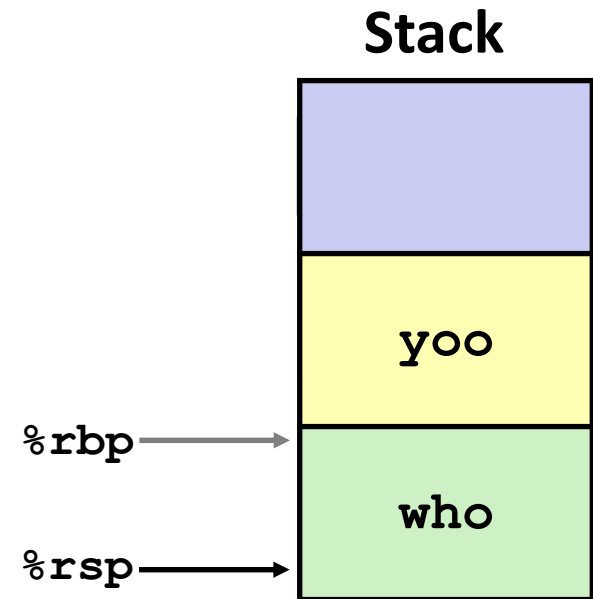
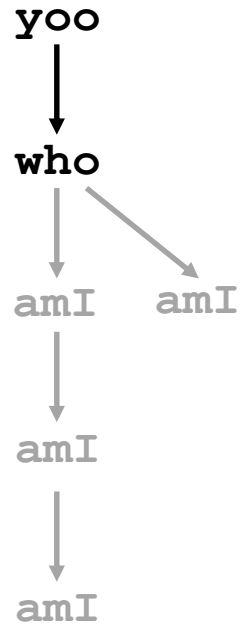
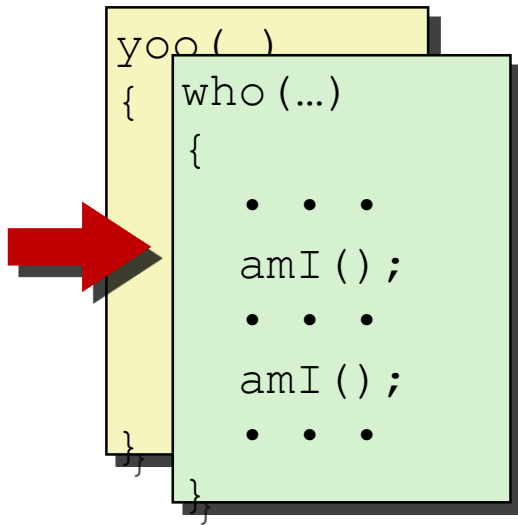



# Example

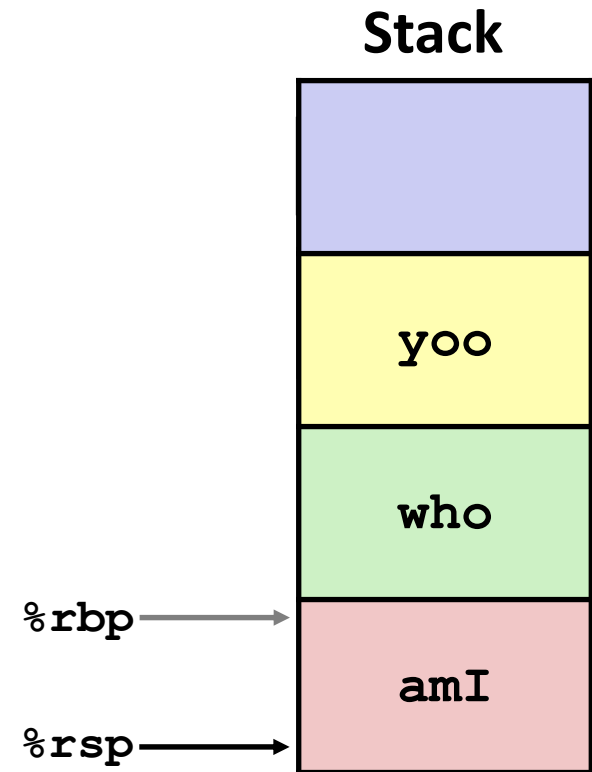
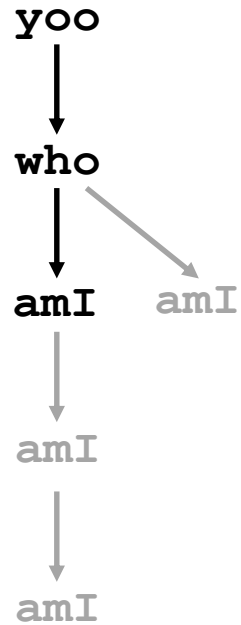
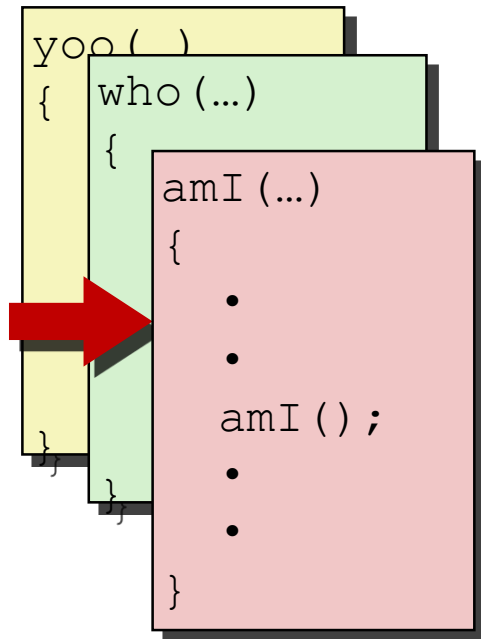

# Example

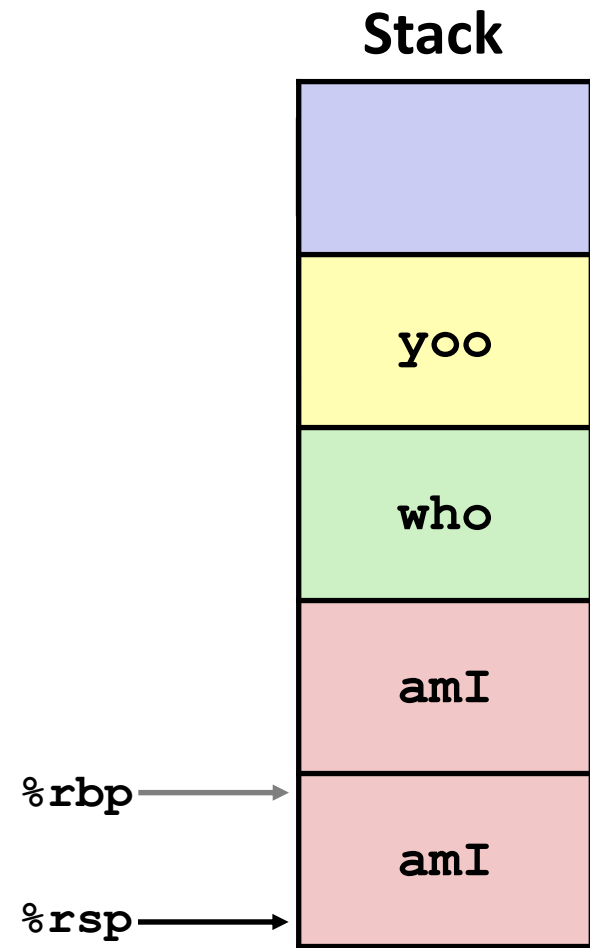
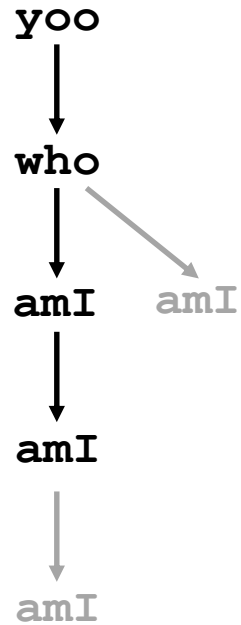
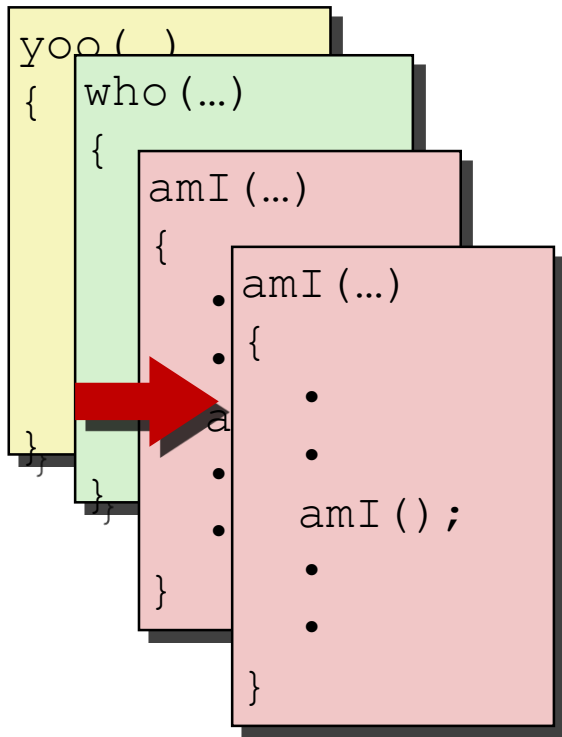

# Example

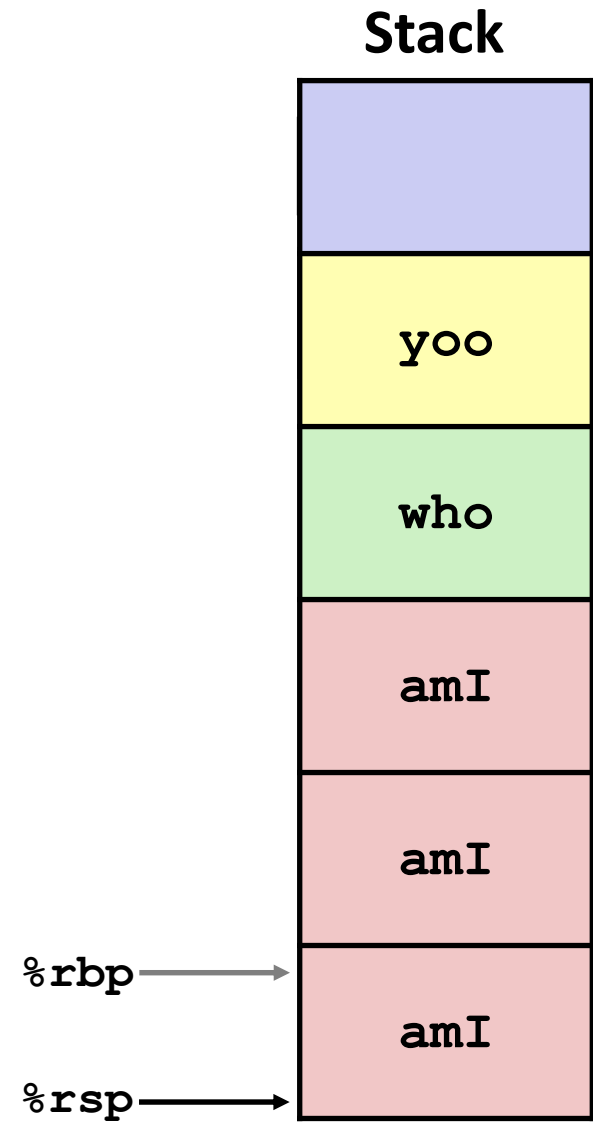
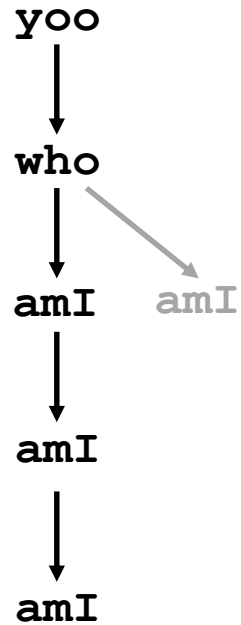
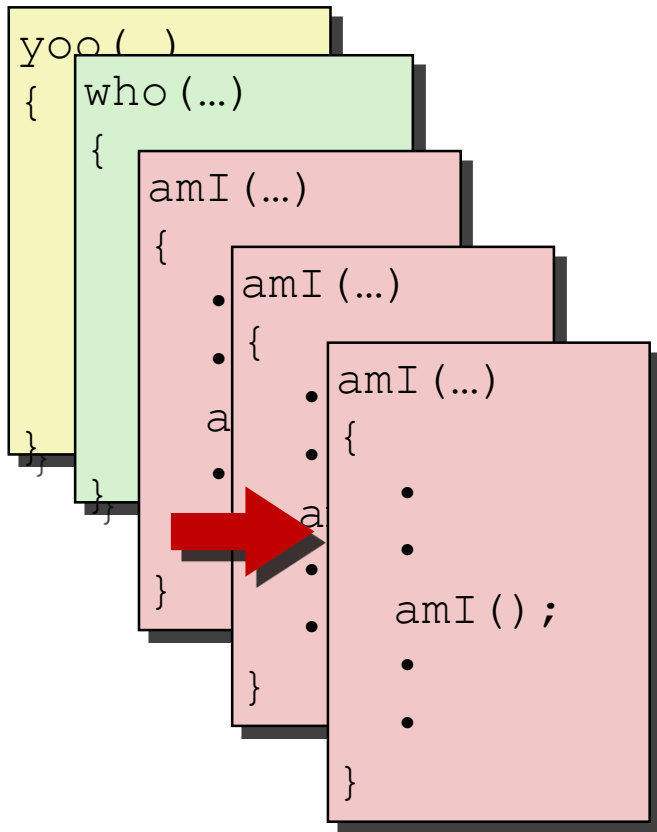

# Example

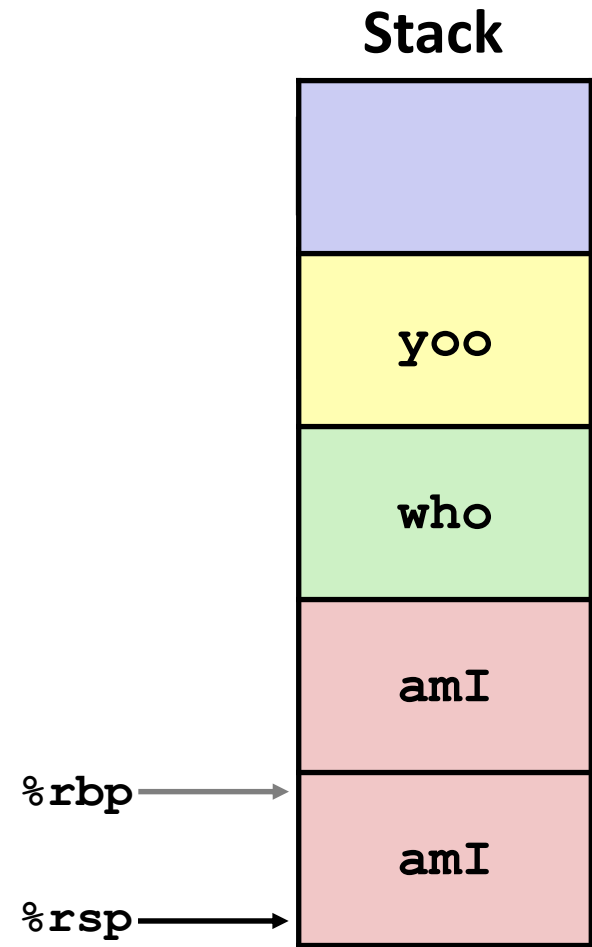
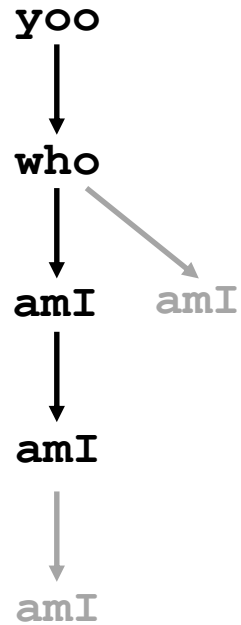
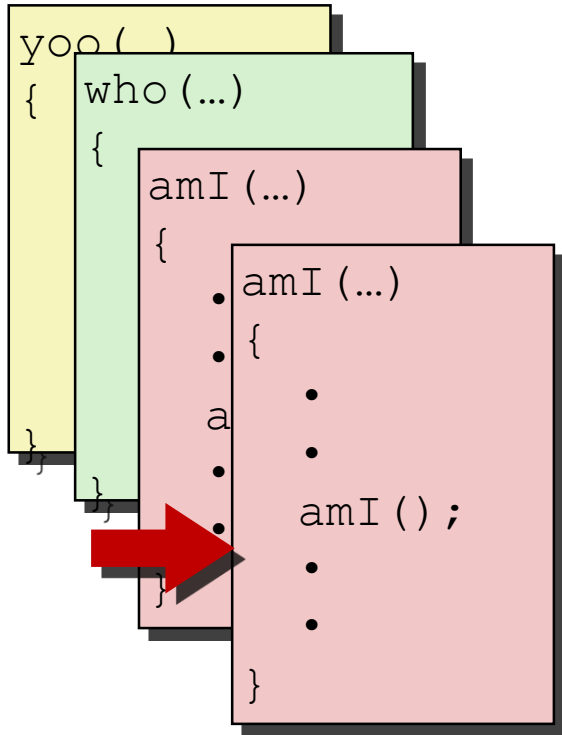

# Example

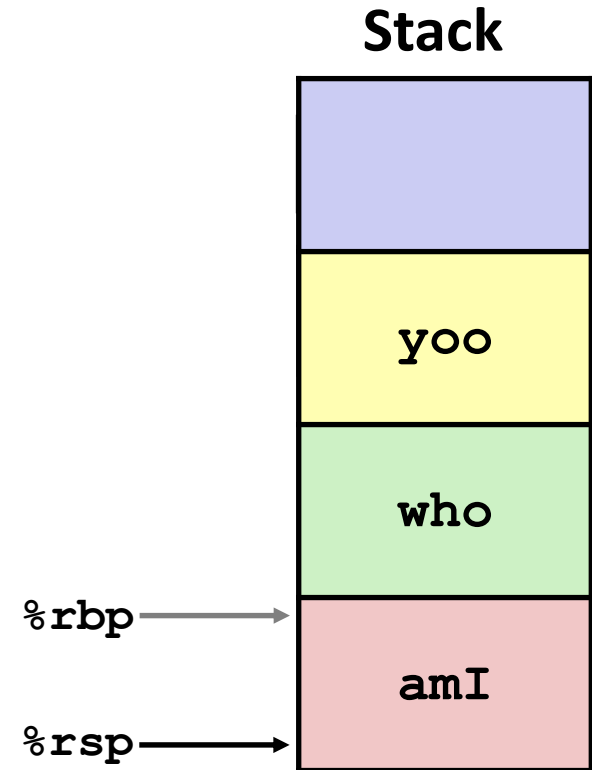
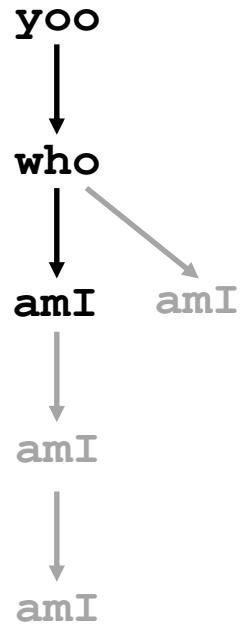
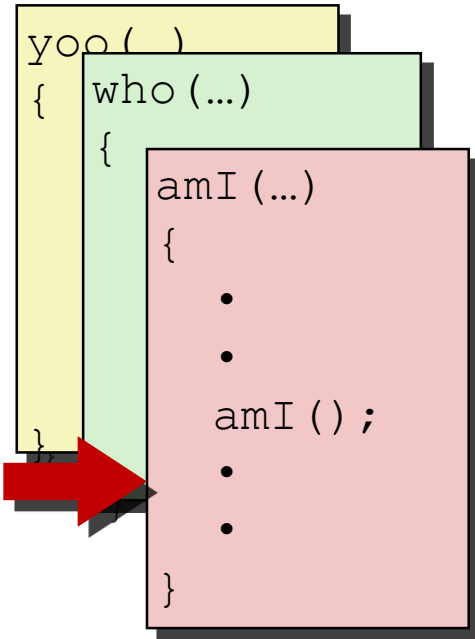

# Example

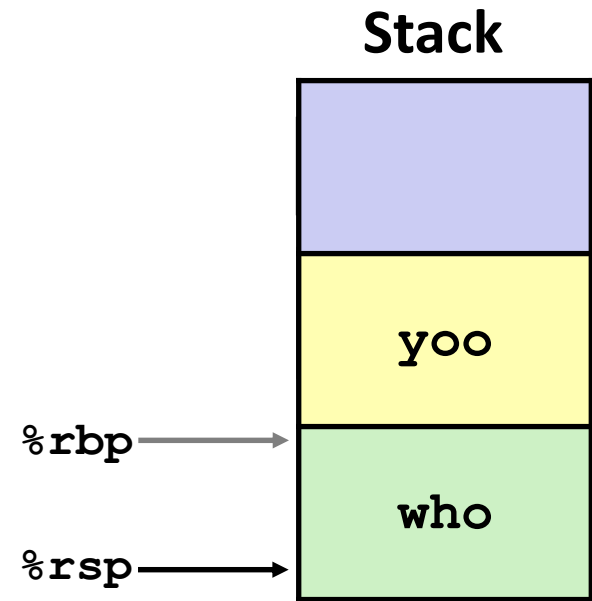
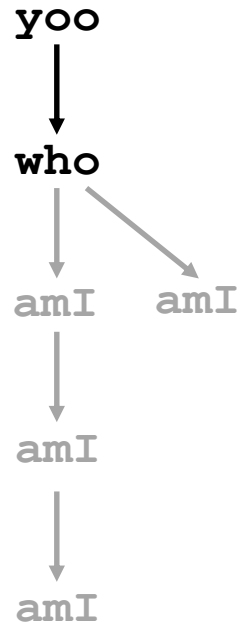
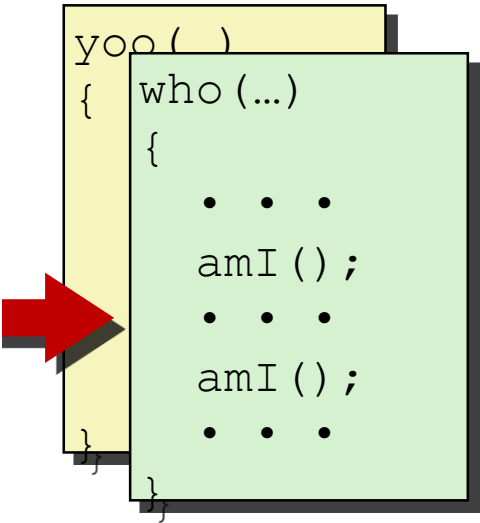

# Example

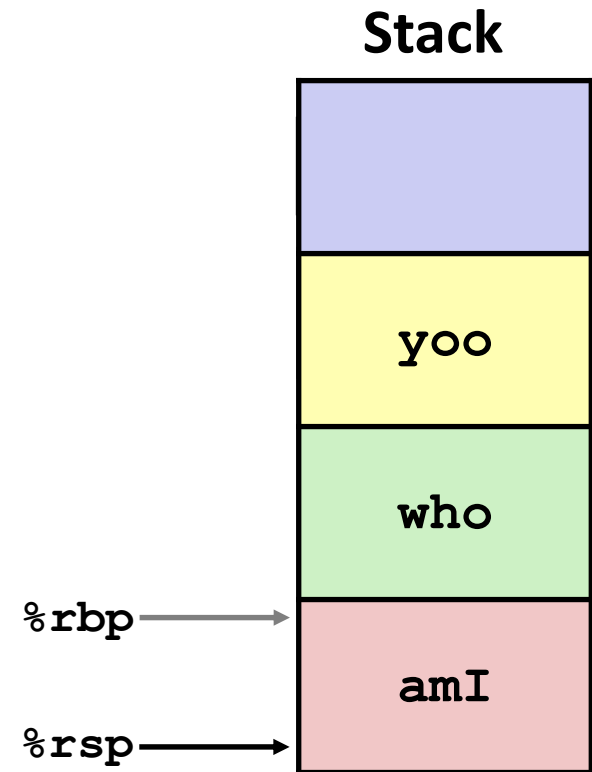
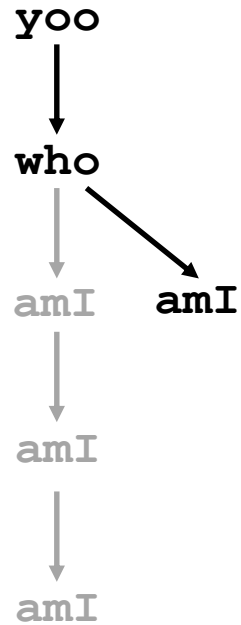
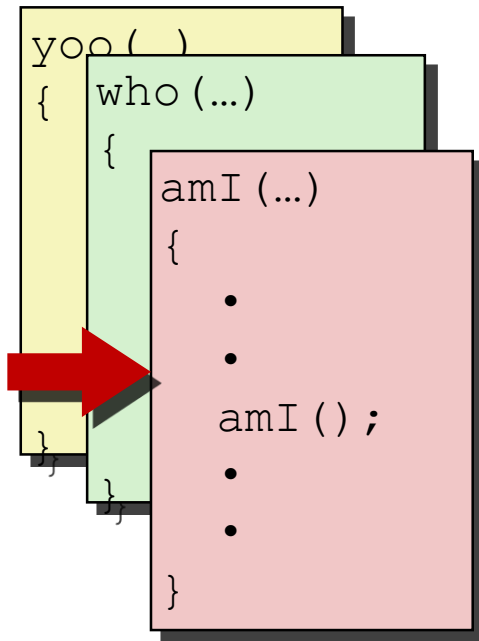

# Example

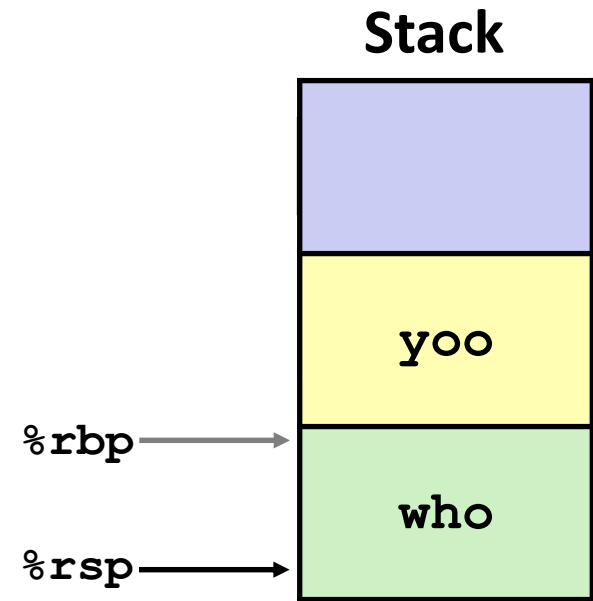
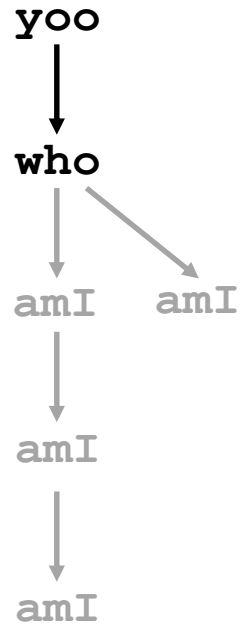
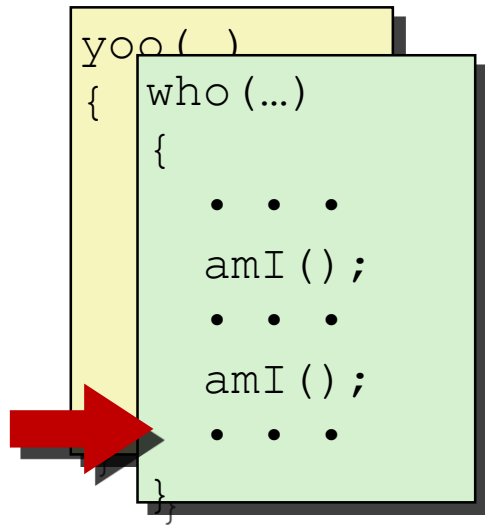



# Example

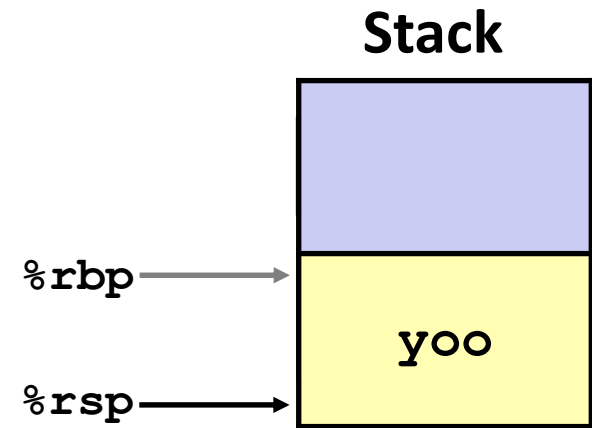
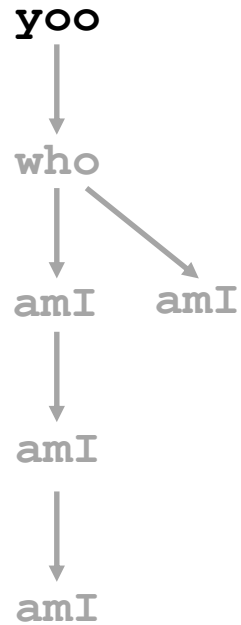
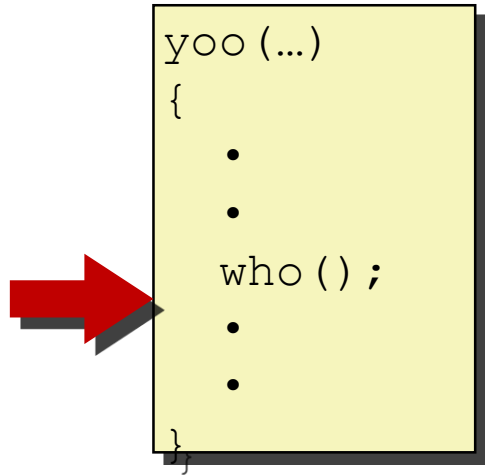

# x86-64/Linux Stack Frame

## ■ Current Stack Frame (“Top” to Bottom)

- “Argument build:”  
Parameters for function about to call
- Local variables  
If can’t keep in registers
- Saved register context
- Old frame pointer (optional)

## ■ Caller Stack Frame

- Return address
  - Pushed by `call` instruction
- Arguments for this call

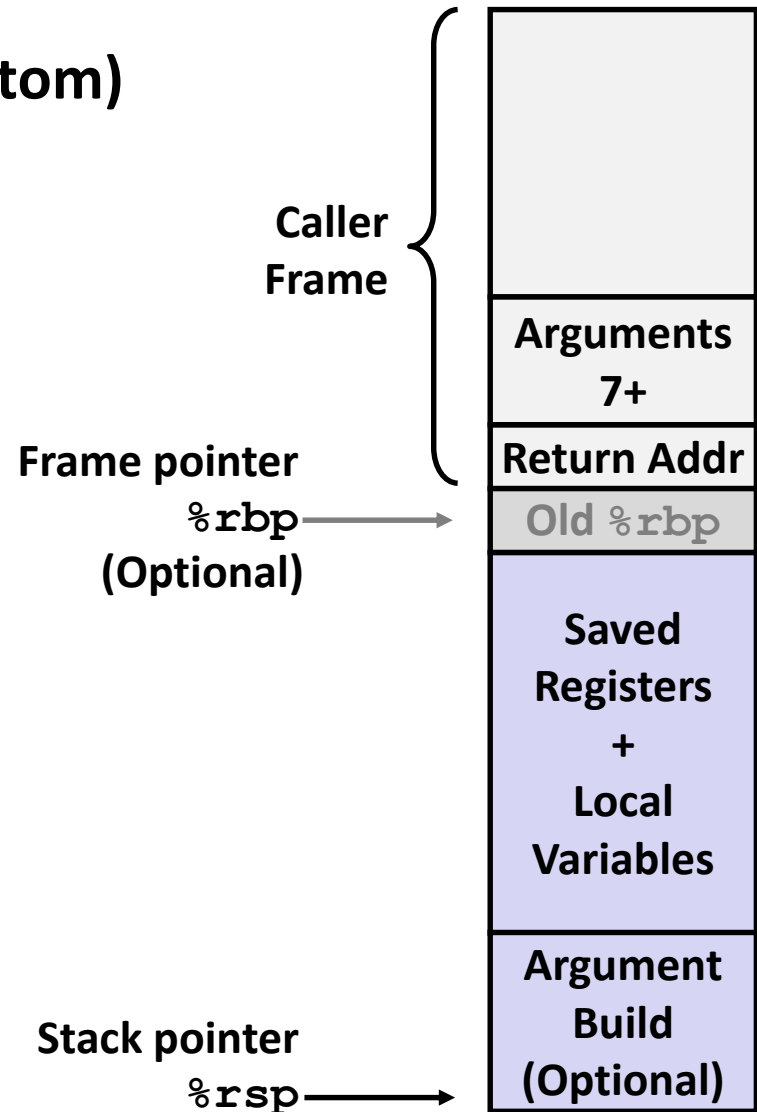

# Example: `incr`

```
long incr(long *p, long val) {
    long x = *p;
    long y = x + val;
    *p = y;
    return x;
}
```

```
incr:
    movq    (%rdi), %rax
    addq   %rax, %rsi
    movq   %rsi, (%rdi)
    ret
```

Register	Use(s)
<code>%rdi</code>	Argument <code>p</code>
<code>%rsi</code>	Argument <code>val</code> , <code>y</code>
<code>%rax</code>	<code>x</code> , Return value

# Example: Calling `incr` #1

```
long call_incr() {
    long v1 = 15213;
    long v2 = incr(&v1, 3000);
    return v1+v2;
}
```

```
call_incr:
    subq    $16, %rsp
    movq    $15213, 8(%rsp)
    movl    $3000, %esi
    leaq    8(%rsp), %rdi
    call    incr
    addq    8(%rsp), %rax
    addq    $16, %rsp
    ret
```

## Initial Stack Structure

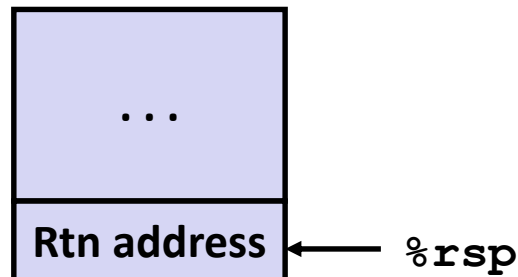

## Resulting Stack Structure

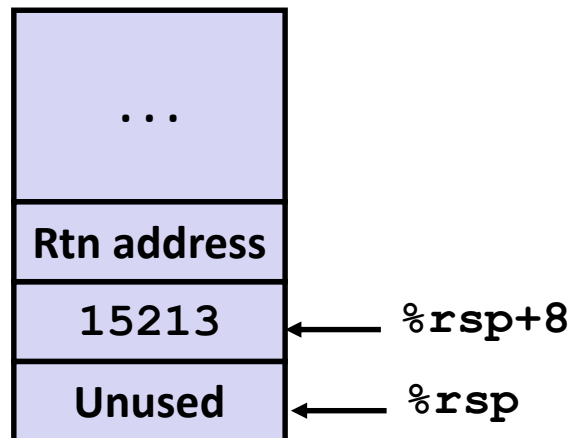

# Example: Calling `incr` #2

```
long call_incr() {
    long v1 = 15213;
    long v2 = incr(&v1, 3000);
    return v1+v2;
}
```

```
call_incr:
    subq    $16, %rsp
    movq    $15213, 8(%rsp)
    movl    $3000, %esi
    leaq    8(%rsp), %rdi
    call    incr
    addq    8(%rsp), %rax
    addq    $16, %rsp
    ret
```

## Stack Structure

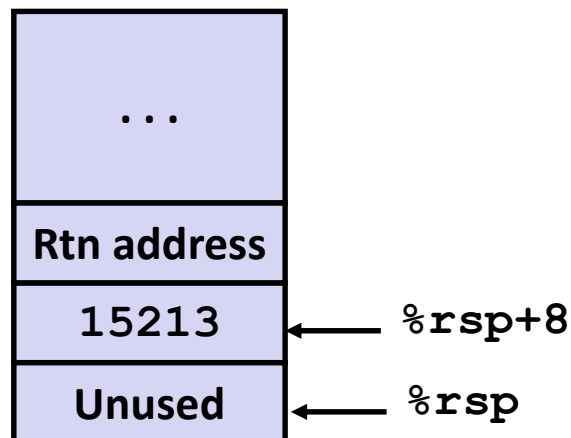

Register	Use(s)
%rdi	&v1
%rsi	3000

# Example: Calling `incr` #2

```
long call_incr() {
    long v1 = 15213;
    long v2 = incr(&v1, 3000);
    return v1+v2;
}
```

## Stack Structure

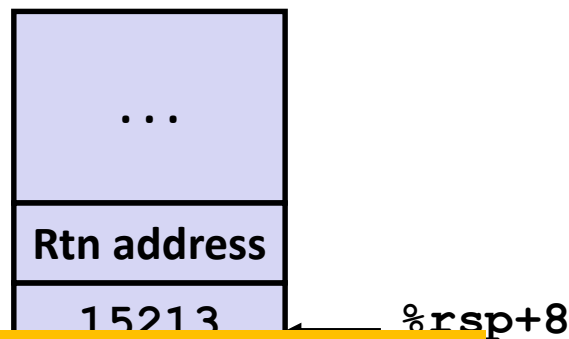

Aside 1: `movl $3000, %esi`

- Note: `movl` -> `%exx` zeros out high order 32 bits.
- Why use `movl` instead of `movq`? 1 byte shorter.

```
call_incr:
    subq    $8, %rsp
    movl    $3000, %esi
    leaq   8(%rsp), %rdi
    call   incr
    addq   8(%rsp), %rax
    addq   $16, %rsp
    ret
```

<code>%rdi</code>	<code>&amp;v1</code>
<code>%rsi</code>	3000

# Example: Calling `incr` #2

```
long call_incr() {
    long v1 = 15213;
    long v2 = incr(&v1, 3000);
    return v1+v2;
}
```

## Stack Structure

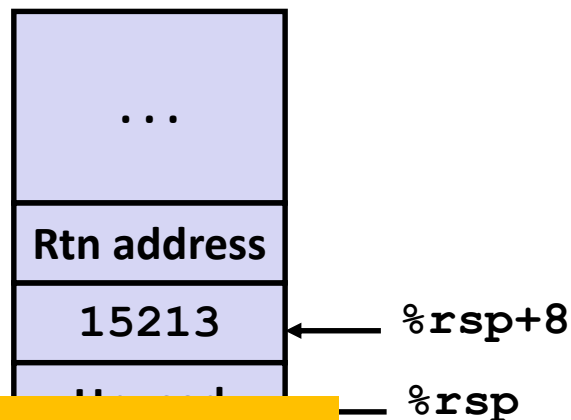

Aside 2: `leaq 8(%rsp), %rdi`

- Computes `%rsp+8`
- Actually, used for what it is meant!

```
leaq    8(%rsp), %rdi
call    incr
addq    8(%rsp), %rax
addq    $16, %rsp
ret
```

	use(s)
<code>%rdi</code>	v1
<code>%rsi</code>	3000

# Example: Calling `incr` #2

```
long call_incr() {
    long v1 = 15213;
    long v2 = incr(&v1, 3000);
    return v1+v2;
}
```

```
call_incr:
    subq    $16, %rsp
    movq    $15213, 8(%rsp)
    movl    $3000, %esi
    leaq   8(%rsp), %rdi
    call   incr
    addq   8(%rsp), %rax
    addq   $16, %rsp
    ret
```

## Stack Structure

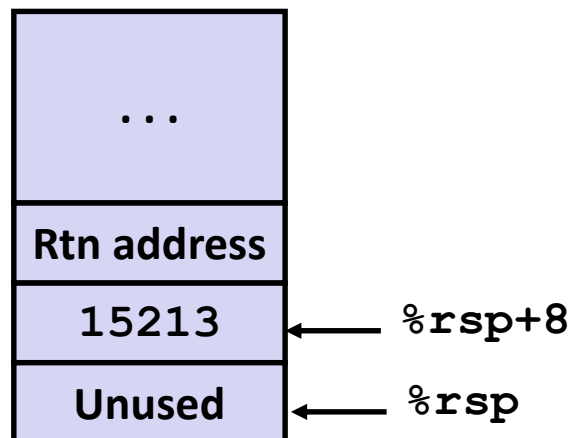

Register	Use(s)
%rdi	&v1
%rsi	3000



# Example: Calling `incr` #3

```
long call_incr() {
    long v1 = 15213;
    long v2 = incr(&v1, 3000);
    return v1+v2;
}
```

```
call_incr:
    subq    $16, %rsp
    movq    $15213, 8(%rsp)
    movl    $3000, %esi
    leaq    8(%rsp), %rdi
    call   incr
    addq    8(%rsp), %rax
    addq    $16, %rsp
    ret
```

## Stack Structure

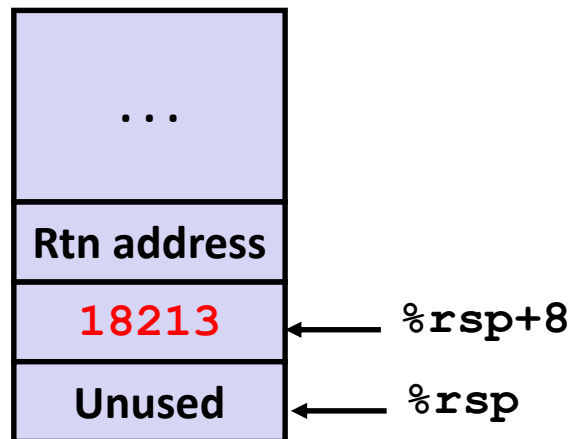

Register	Use(s)
%rdi	&v1
%rsi	3000

# Example: Calling `incr` #4

```
long call_incr() {
    long v1 = 15213;
    long v2 = incr(&v1, 3000);
    return v1+v2;
}
```

```
call_incr:
    subq    $16, %rsp
    movq    $15213, 8(%rsp)
    movl    $3000, %esi
    leaq   8(%rsp), %rdi
    call   incr
    addq   8(%rsp), %rax
    addq   $16, %rsp
    ret
```

## Stack Structure

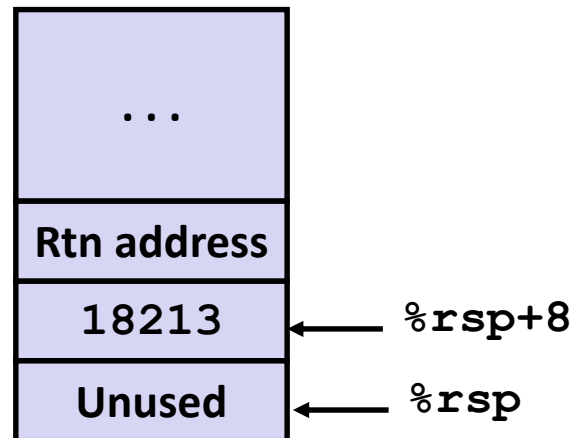

Register	Use(s)
%rax	Return value

# Example: Calling `incr` #5a

```
long call_incr() {
    long v1 = 15213;
    long v2 = incr(&v1, 3000);
    return v1+v2;
}
```

```
call_incr:
    subq    $16, %rsp
    movq    $15213, 8(%rsp)
    movl    $3000, %esi
    leaq    8(%rsp), %rdi
    call    incr
    addq    8(%rsp), %rax
    addq    $16, %rsp
    ret
```

## Stack Structure

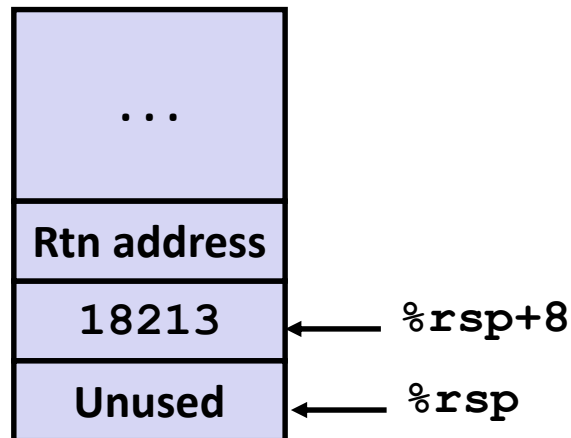

Register	Use(s)
<code>%rax</code>	Return value

## Updated Stack Structure

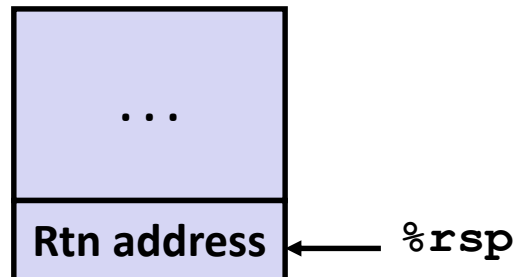

# Example: Calling `incr` #5b

```
long call_incr() {
    long v1 = 15213;
    long v2 = incr(&v1, 3000);
    return v1+v2;
}
```

```
call_incr:
    subq    $16, %rsp
    movq    $15213, 8(%rsp)
    movl    $3000, %esi
    leaq    8(%rsp), %rdi
    call    incr
    addq    8(%rsp), %rax
    addq    $16, %rsp
    ret
```

## Updated Stack Structure

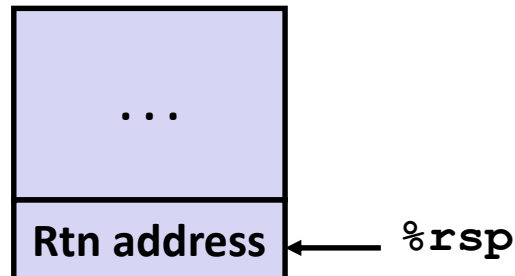

Register	Use(s)
<code>%rax</code>	Return value

## Final Stack Structure

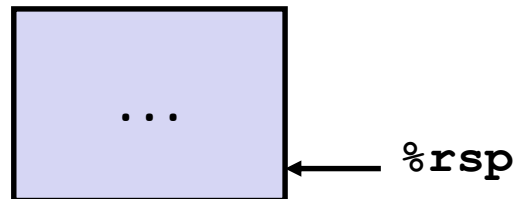

# Register Saving Conventions

## ■ When procedure `yoo` calls `who`:

- `yoo` is the *caller*
- `who` is the *callee*

## ■ Can register be used for temporary storage?

```
yoo:
    . . .
    movq $15213, %rdx
    call who
    addq %rdx, %rax
    . . .
    ret
```

```
who:
    . . .
    subq $18213, %rdx
    . . .
    ret
```

- Contents of register `%rdx` overwritten by `who`
- This could be trouble → something should be done!
  - Need some coordination

# Register Saving Conventions

- When procedure *yoo* calls *who*:
  - *yoo* is the *caller*
  - *who* is the *callee*
- Can register be used for temporary storage?
- Conventions
  - *“Caller Saved”*
    - Caller saves temporary values in its frame before the call
  - *“Callee Saved”*
    - Callee saves temporary values in its frame before using
    - Callee restores them before returning to caller

# x86-64 Linux Register Usage #1

## ■ `%rax`

- Return value
- Also caller-saved
- Can be modified by procedure

## ■ `%rdi, ..., %r9`

- Arguments
- Also caller-saved
- Can be modified by procedure

## ■ `%r10, %r11`

- Caller-saved
- Can be modified by procedure

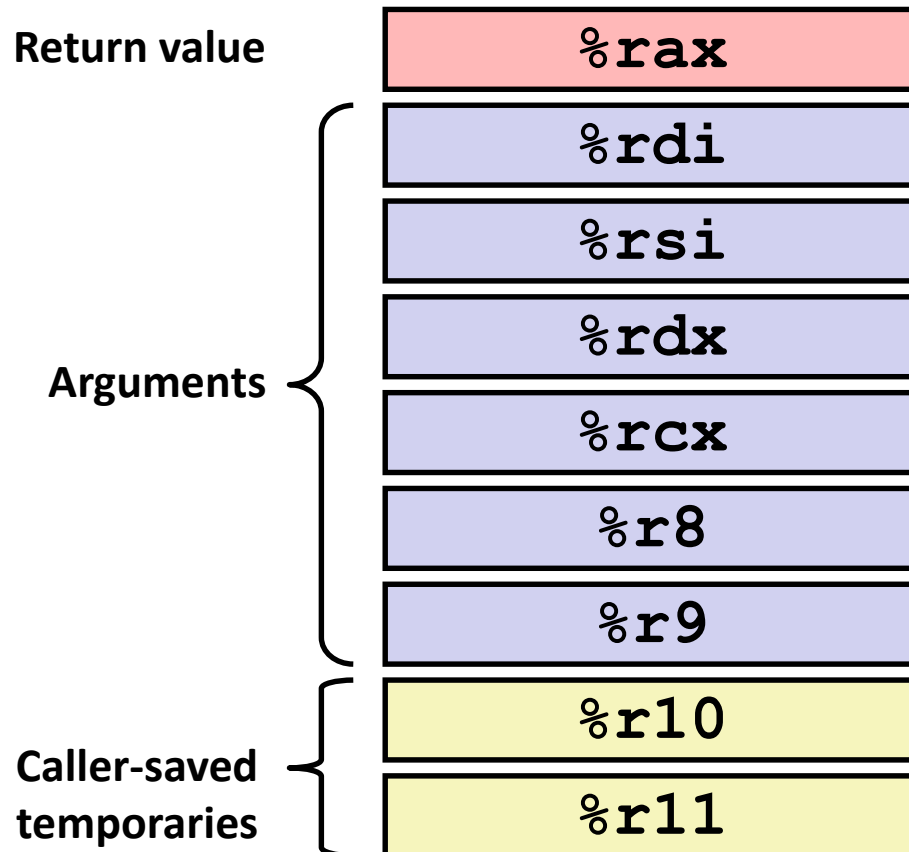

# x86-64 Linux Register Usage #2

## ■ `%rbx`, `%r12`, `%r13`, `%r14`

- Callee-saved
- Callee must save & restore

## ■ `%rbp`

- Callee-saved
- Callee must save & restore
- May be used as frame pointer
- Can mix & match

## ■ `%rsp`

- Special form of callee save
- Restored to original value upon exit from procedure

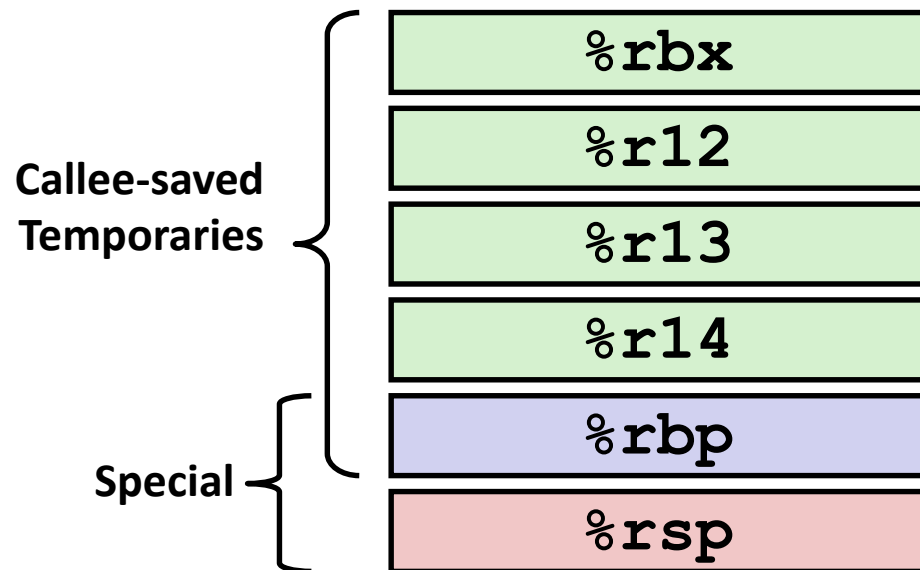



# Callee-Saved Example #1

```
long call_incr2(long x) {  
    long v1 = 15213;  
    long v2 = incr(&v1, 3000);  
    return x+v2;  
}
```

Initial Stack Structure

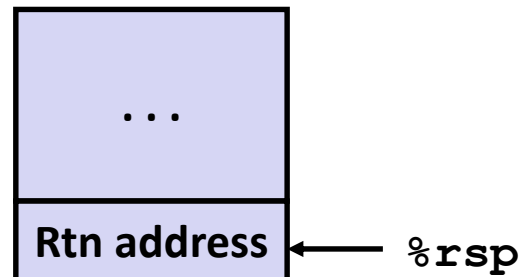

- X comes in register `%rdi`.
- We need `%rdi` for the call to `incr`.
- Where should be put `x`, so we can use it after the call to `incr`?

# Callee-Saved Example #2

```
long call_incr2(long x) {
    long v1 = 15213;
    long v2 = incr(&v1, 3000);
    return x+v2;
}
```

```
call_incr2:
    pushq   %rbx ← Overwritten: Need to save
    subq    $16, %rsp
    movq    %rdi, %rbx
    movq    $15213, 8(%rsp)
    movl    $3000, %esi
    leaq    8(%rsp), %rdi
    call    incr
    addq    %rbx, %rax
    addq    $16, %rsp
    popq    %rbx
    ret
```

## Initial Stack Structure

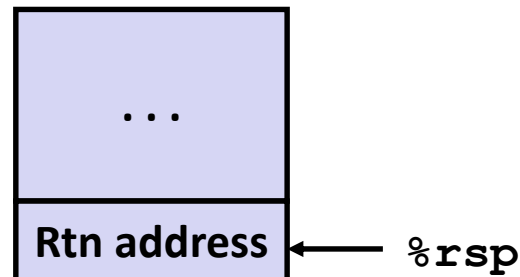

## Resulting Stack Structure

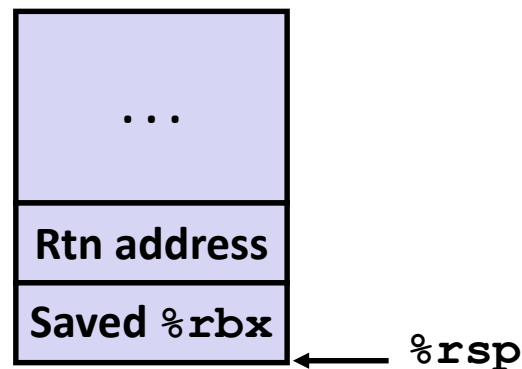

# Callee-Saved Example #3

```
long call_incr2(long x) {
    long v1 = 15213;
    long v2 = incr(&v1, 3000);
    return x+v2;
}
```

```
call_incr2:
    pushq    %rbx
    subq    $16, %rsp
    movq    %rdi, %rbx
    movq    $15213, 8(%rsp)
    movl    $3000, %esi
    leaq    8(%rsp), %rdi
    call    incr
    addq    %rbx, %rax
    addq    $16, %rsp
    popq    %rbx
    ret
```

## Initial Stack Structure

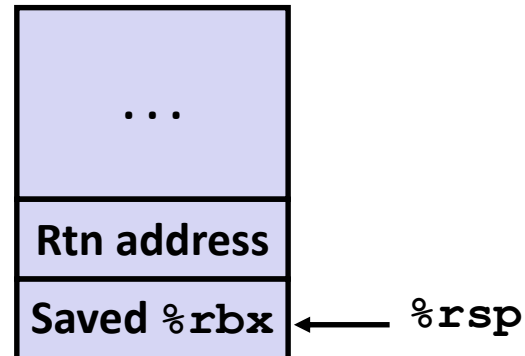

## Resulting Stack Structure

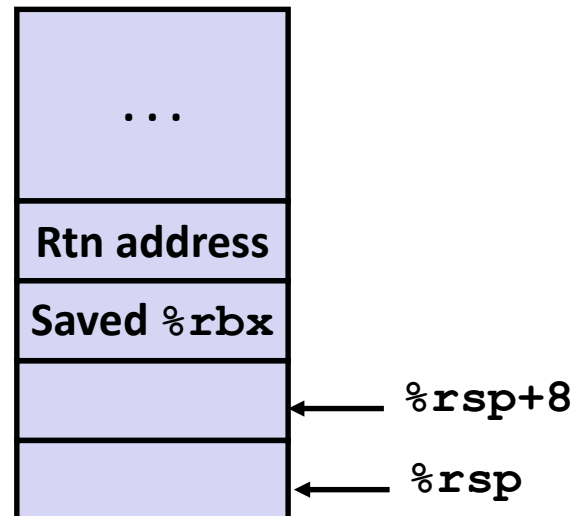

# Callee-Saved Example #4

```
long call_incr2(long x) {
    long v1 = 15213;
    long v2 = incr(&v1, 3000);
    return x+v2;
}
```

```
call_incr2:
    pushq    %rbx
    subq    $16, %rsp
    movq    %rdi, %rbx
    movq    $15213, 8(%rsp)
    movl    $3000, %esi
    leaq    8(%rsp), %rdi
    call    incr
    addq    %rbx, %rax
    addq    $16, %rsp
    popq    %rbx
    ret
```

## Stack Structure

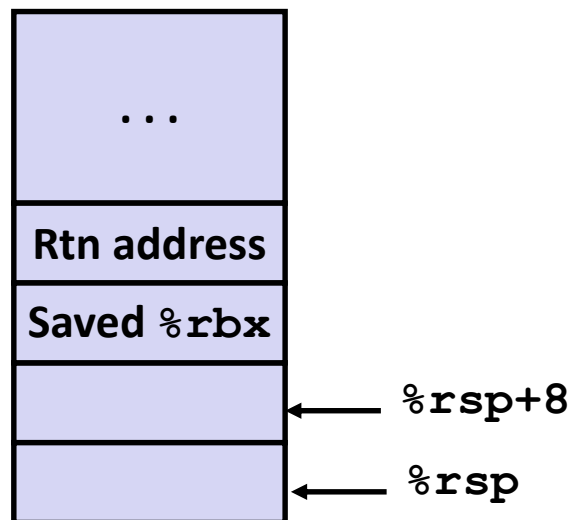

- **x** is saved in **%rbx**,  
a callee saved register

# Callee-Saved Example #5

```
long call_incr2(long x) {
    long v1 = 15213;
    long v2 = incr(&v1, 3000);
    return x+v2;
}
```

```
call_incr2:
    pushq    %rbx
    subq     $16, %rsp
    movq     %rdi, %rbx
    movq     $15213, 8(%rsp)
    movl     $3000, %esi
    leaq    8(%rsp), %rdi
    call    incr
    addq    %rbx, %rax
    addq    $16, %rsp
    popq    %rbx
    ret
```

## Stack Structure

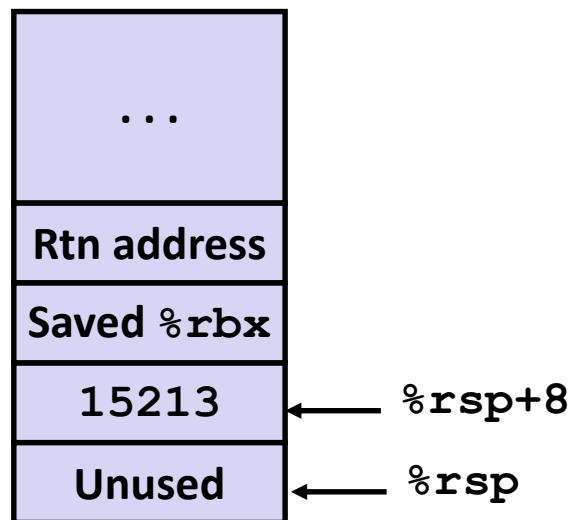

- **x** is saved in **%rbx**,  
a callee saved register

# Callee-Saved Example #6

```
long call_incr2(long x) {
    long v1 = 15213;
    long v2 = incr(&v1, 3000);
    return x+v2;
}
```

```
call_incr2:
    pushq    %rbx
    subq    $16, %rsp
    movq    %rdi, %rbx
    movq    $15213, 8(%rsp)
    movl    $3000, %esi
    leaq    8(%rsp), %rdi
    call    incr
    addq    %rbx, %rax
    addq    $16, %rsp
    popq    %rbx
    ret
```

## Stack Structure

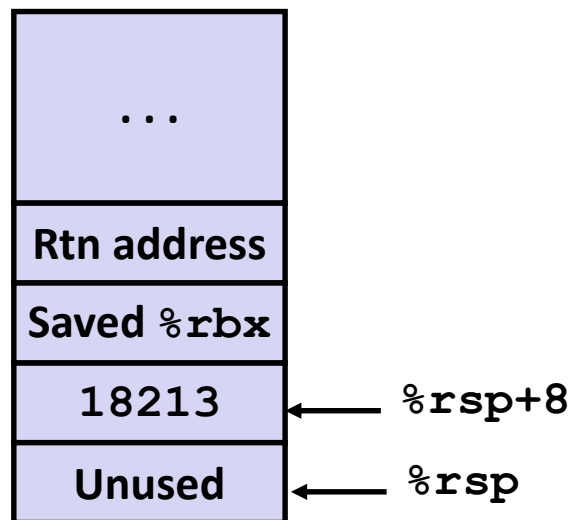

Upon return from `incr`:

- `x` is safe in `%rbx`
- Return result `v2` is in `%rax`
- Compute `x+v2`

# Callee-Saved Example #7

```
long call_incr2(long x) {
    long v1 = 15213;
    long v2 = incr(&v1, 3000);
    return x+v2;
}
```

```
call_incr2:
    pushq    %rbx
    subq    $16, %rsp
    movq    %rdi, %rbx
    movq    $15213, 8(%rsp)
    movl    $3000, %esi
    leaq    8(%rsp), %rdi
    call    incr
    addq    %rbx, %rax
    addq    $16, %rsp
    popq    %rbx
    ret
```

## Stack Structure

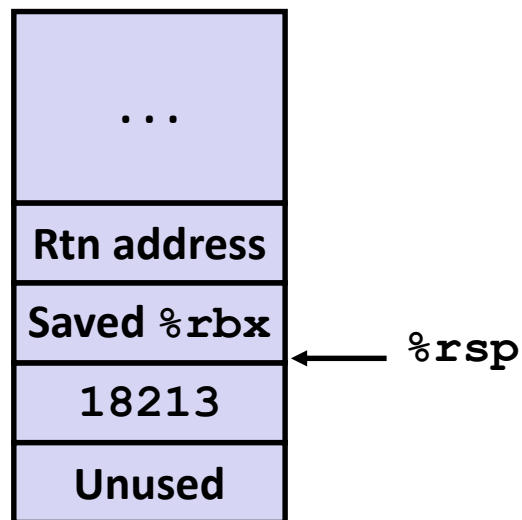

- Return result in **%rax**

# Callee-Saved Example #8

```
long call_incr2(long x) {
    long v1 = 15213;
    long v2 = incr(&v1, 3000);
    return x+v2;
}
```

```
call_incr2:
    pushq    %rbx
    subq    $16, %rsp
    movq    %rdi, %rbx
    movq    $15213, 8(%rsp)
    movl    $3000, %esi
    leaq    8(%rsp), %rdi
    call    incr
    addq    %rbx, %rax
    addq    $16, %rsp
    popq    %rbx
    ret
```

## Initial Stack Structure

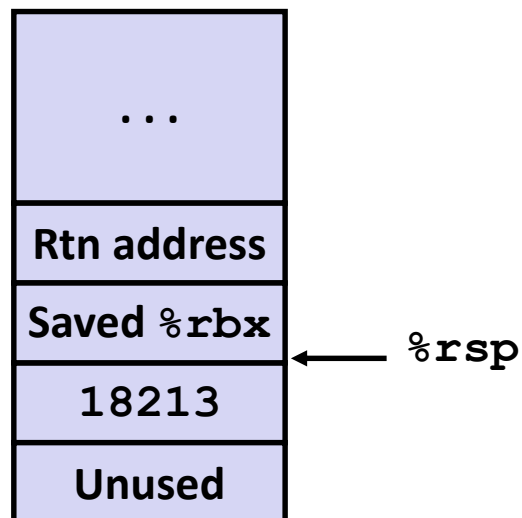

## final Stack Structure

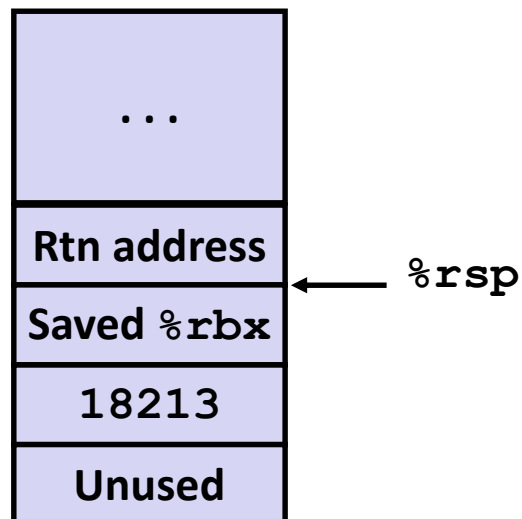



# Today

## ■ Procedures

- Mechanisms
- Stack Structure
- Calling Conventions
  - Passing control
  - Passing data
  - Managing local data
- **Illustration of Recursion**

# Recursive Function

```
/* Recursive popcount */
long pcount_r(unsigned long x) {
    if (x == 0)
        return 0;
    else
        return (x & 1)
            + pcount_r(x >> 1);
}
```

```
pcount_r:
    movl    $0, %eax
    testq   %rdi, %rdi
    je      .L6
    pushq   %rbx
    movq    %rdi, %rbx
    andl    $1, %ebx
    shrq    %rdi
    call    pcount_r
    addq    %rbx, %rax
    popq    %rbx
.L6:
    rep; ret
```

# Recursive Function Terminal Case

```

/* Recursive popcount */
long pcount_r(unsigned long x) {
    if (x == 0)
        return 0;
    else
        return (x & 1)
            + pcount_r(x >> 1);
}

```

```

pcount_r:
    movl    $0, %eax
    testq   %rdi, %rdi
    je      .L6
    pushq   %rbx
    movq    %rdi, %rbx
    andl    $1, %ebx
    shrq    %rdi
    call    pcount_r
    addq    %rbx, %rax
    popq    %rbx
.L6:
    rep; ret

```

Register	Use(s)	Type
%rdi	x	Argument
%rax	Return value	Return value

# Recursive Function Register Save

```

/* Recursive popcount */
long pcount_r(unsigned long x) {
    if (x == 0)
        return 0;
    else
        return (x & 1)
            + pcount_r(x >> 1);
}

```

```

pcount_r:
    movl    $0, %eax
    testq   %rdi, %rdi
    je     .L6
    pushq   %rbx
    movq   %rdi, %rbx
    andl   $1, %ebx
    shrq   %rdi
    call   pcount_r
    addq   %rbx, %rax
    popq   %rbx
.L6:
    rep; ret

```

Register	Use(s)	Type
%rdi	x	Argument

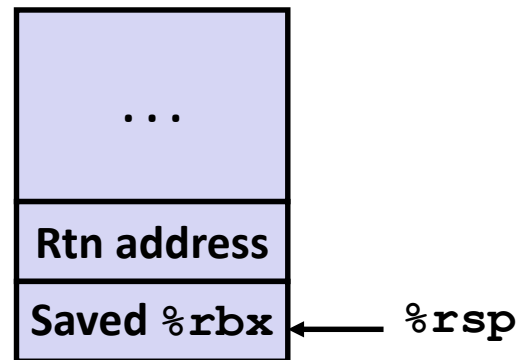

# Recursive Function Call Setup

```

/* Recursive popcount */
long pcount_r(unsigned long x) {
    if (x == 0)
        return 0;
    else
        return (x & 1)
            + pcount_r(x >> 1);
}

```

```

pcount_r:
    movl    $0, %eax
    testq   %rdi, %rdi
    je     .L6
    pushq   %rbx
    movq    %rdi, %rbx
    andl    $1, %ebx
    shrq    %rdi
    call    pcount_r
    addq    %rbx, %rax
    popq    %rbx
.L6:
    rep; ret

```

Register	Use(s)	Type
%rdi	x >> 1	Recursive argument
%rbx	x & 1	Callee-saved

# Recursive Function Call

```

/* Recursive popcount */
long pcount_r(unsigned long x) {
    if (x == 0)
        return 0;
    else
        return (x & 1)
            + pcount_r(x >> 1);
}

```

```

pcount_r:
    movl    $0, %eax
    testq   %rdi, %rdi
    je      .L6
    pushq   %rbx
    movq    %rdi, %rbx
    andl    $1, %ebx
    shrq    %rdi
    call    pcount_r
    addq    %rbx, %rax
    popq    %rbx
.L6:
    rep; ret

```

Register	Use(s)	Type
%rbx	x & 1	Callee-saved
%rax	Recursive call return value	

# Recursive Function Result

```

/* Recursive popcount */
long pcount_r(unsigned long x) {
    if (x == 0)
        return 0;
    else
        return (x & 1)
            + pcount_r(x >> 1);
}

```

```

pcount_r:
    movl    $0, %eax
    testq   %rdi, %rdi
    je      .L6
    pushq   %rbx
    movq    %rdi, %rbx
    andl    $1, %ebx
    shrq    %rdi
    call    pcount_r
    addq    %rbx, %rax
    popq    %rbx
.L6:
    rep; ret

```

Register	Use(s)	Type
%rbx	x & 1	Callee-saved
%rax	Return value	

# Recursive Function Completion

```

/* Recursive popcount */
long pcount_r(unsigned long x) {
    if (x == 0)
        return 0;
    else
        return (x & 1)
            + pcount_r(x >> 1);
}

```

```

pcount_r:
    movl    $0, %eax
    testq   %rdi, %rdi
    je     .L6
    pushq   %rbx
    movq    %rdi, %rbx
    andl    $1, %ebx
    shrq    %rdi
    call    pcount_r
    addq    %rbx, %rax
    popq    %rbx
.L6:
    rep; ret

```

Register	Use(s)	Type
%rax	Return value	Return value

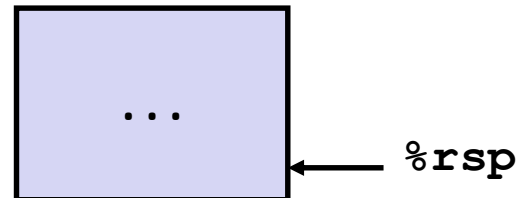



# Observations About Recursion

## ■ Handled Without Special Consideration

- Stack frames mean that each function call has private storage
  - Saved registers & local variables
  - Saved return pointer
- Register saving conventions prevent one function call from corrupting another's data
  - Unless the C code explicitly does so (e.g., buffer overflow in Lecture 9)
- Stack discipline follows call / return pattern
  - If P calls Q, then Q returns before P
  - Last-In, First-Out

## ■ Also works for mutual recursion

- P calls Q; Q calls P

# x86-64 Procedure Summary

## ■ Important Points

- Stack is the right data structure for procedure call/return
  - If P calls Q, then Q returns before P

## ■ Recursion (& mutual recursion) handled by normal calling conventions

- Can safely store values in local stack frame and in callee-saved registers
- Put function arguments at top of stack
- Result return in `%rax`

## ■ Pointers are addresses of values

- On stack or global

